

POLÍTICA DE QUALIDADE

Trabalhar com QUALIDADE, unindo forças com a participação de todos e superando sempre as expectativas dos clientes.

A ASA ALUMÍNIO se reserva ao direito de efetuar, a qualquer momento e sem prévio aviso, todas as modificações que julgar necessárias.

As dimensões, espessuras e pesos dos perfis indicados neste catálogo são teóricos, podendo variar em função de tolerâncias previstas nas normas ABNT.

O conteúdo deste catálogo é de propriedade da ASA ALUMÍNIO, e não pode ser copiado em parte ou na sua totalidade sem prévia aprovação.

1 Apresentação 04

2 Tipologias 05

3 Perfis 13

4 Acessórios 47

5 Gráficos 69

6 Normas 79

O Sistema MEGA é composto por três Linhas personificadas que atendem todos os níveis de exigência.

Conseqüentemente, são três bitolas distintas, com a propriedade de se comunicarem entre si, permitindo, assim, obter-se a mais ampla gama de tipologias.

Essa notória versatilidade de composição é uma inovação exclusiva desta família, composta por:



A Linha Mega 32 foi desenvolvida para um nível de sofisticação mais elevado. Os perfis mais robustos apresentam-se como soluções adequadas para fechamentos de grandes vãos.



TIPOLOGIAS

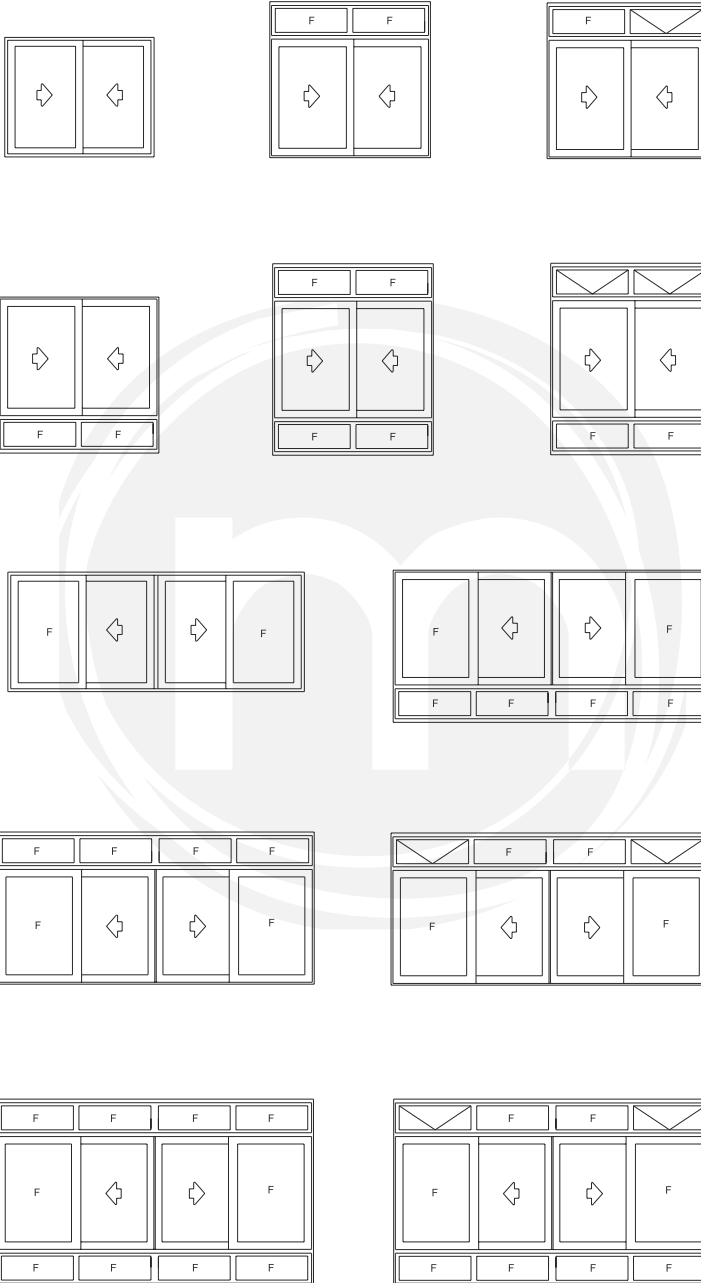



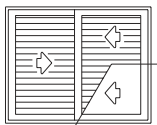
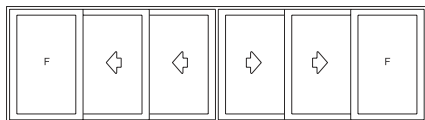
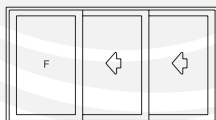
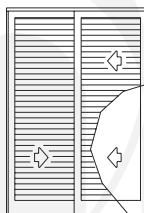
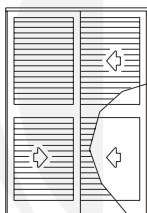
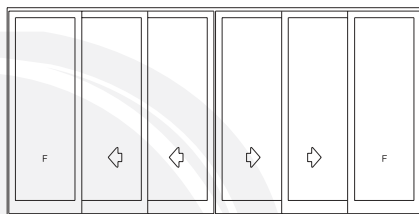
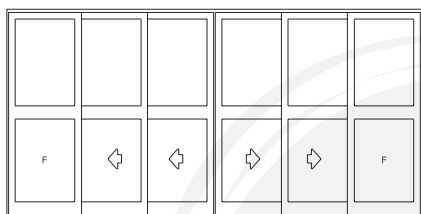
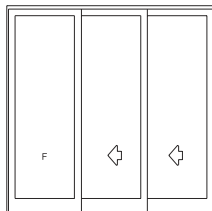
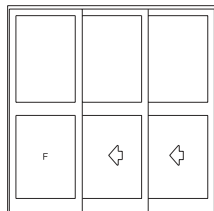

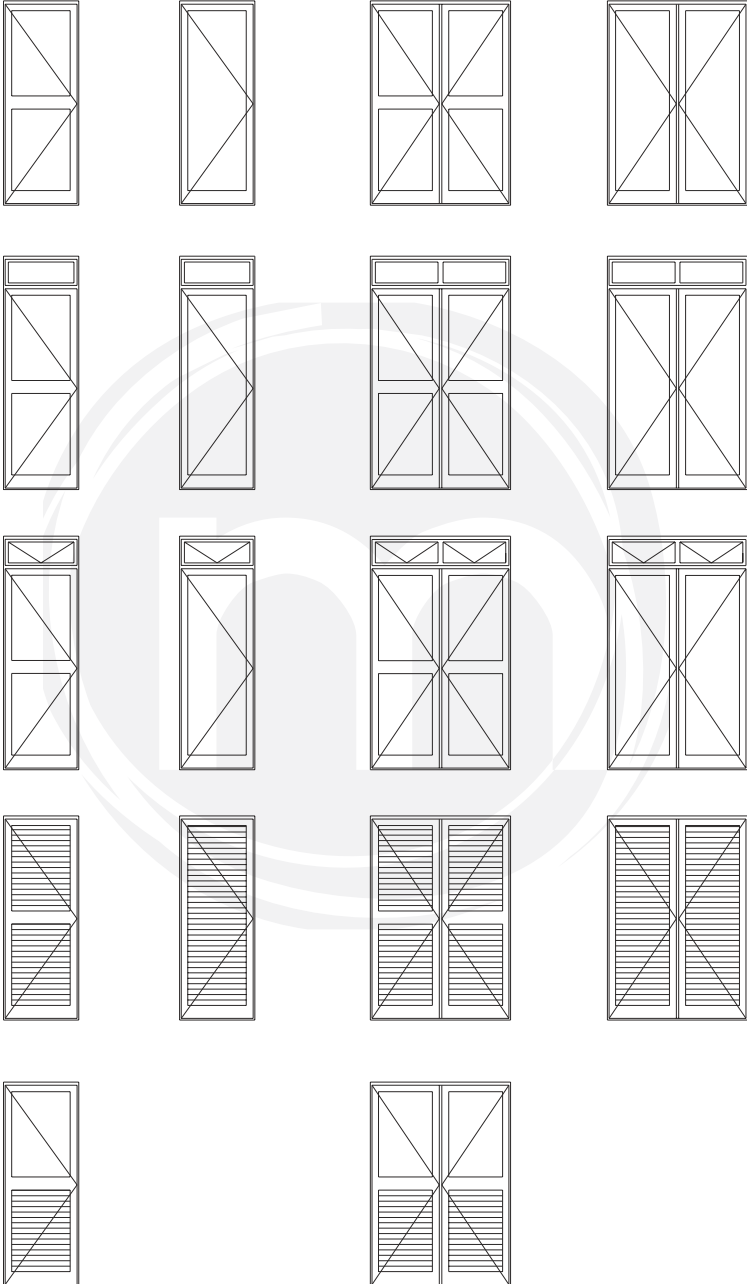

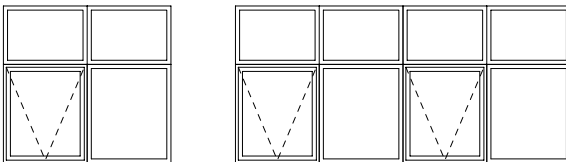
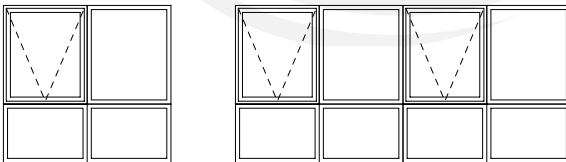
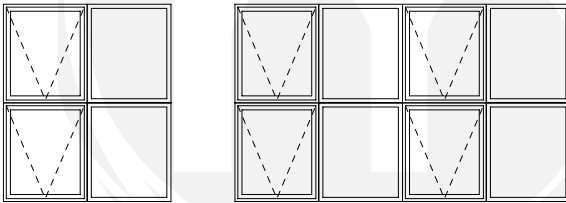
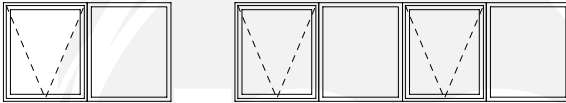
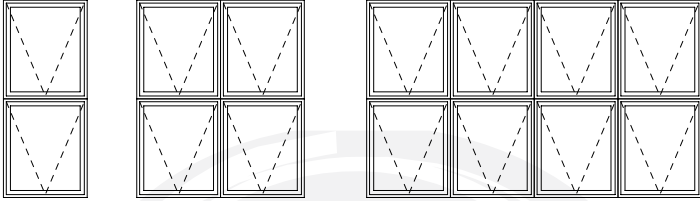
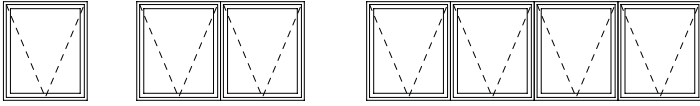

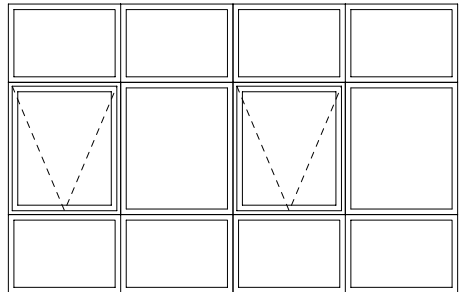
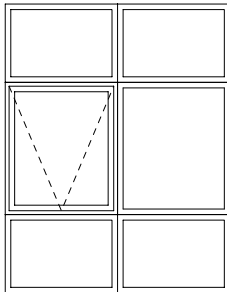
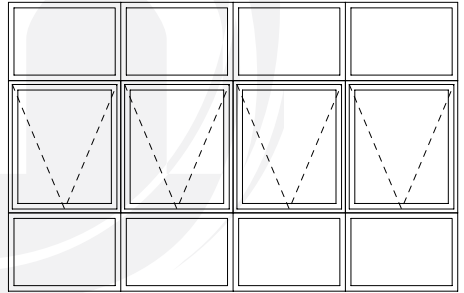
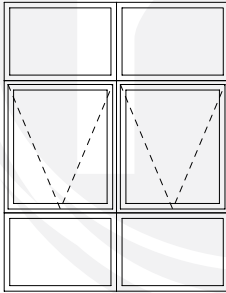
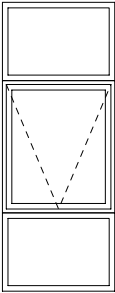
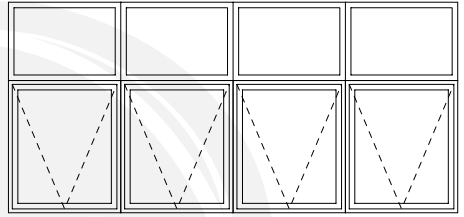
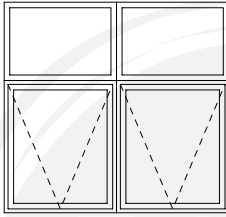
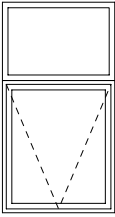
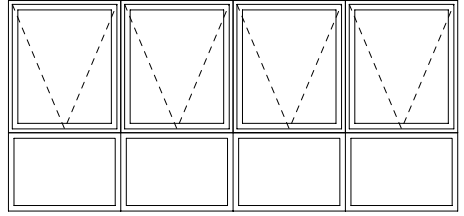
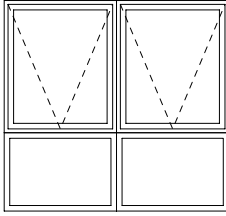
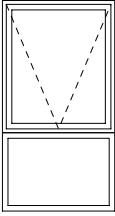

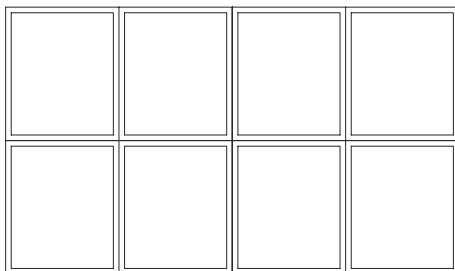
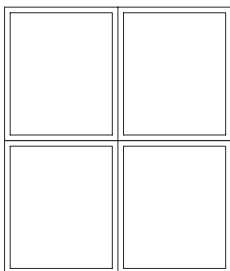
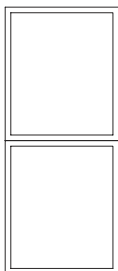
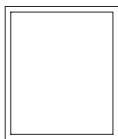
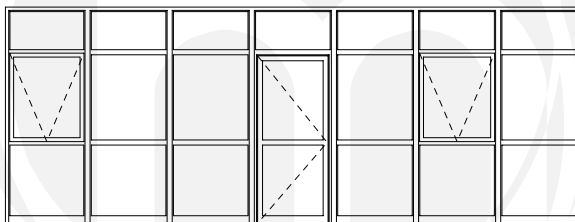
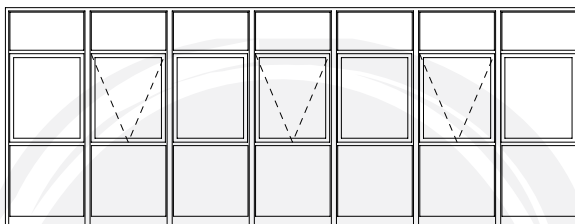
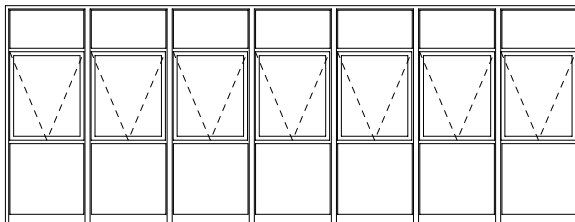



Índice de perfis

código	descrição	pág	código	descrição	pág	código	descrição	pág
CA-006	Macho de conexão	19	MG32-046	Lamina contra-peso de 48 mm	44	MG32-113	Montante central duplo	33
CA-011	Cunha de conexão	19	MG32-047	Montante da folha de giro 45°	36	MG32-157	Montante perimetral	37
CA-028	Contramarco	17	MG32-049	Marco lateral com 01 mata junta	24	MG32-158	Travessa do marco	37
CA-032	Contramarco	16	MG32-051	Marco do fixo	36	MG32-159	Coluna do marco	38
CA-060	Contramarco	15	MG32-052	Trilho único	28	MG32-173	Travessa do marco	38
CA-063	Contramarco	15	MG32-059	Marco superior da caixa integrada	43	MG32-174	Marco perimetral	37
CA-096	Contramarco	16	MG32-061	Trilho inferior da janela integrada	41	MG32-175	Reversor do marco	37
CA-098	Contramarco	15	MG32-062	Lamina contra-peso de 39,2 mm	44	MG32-610	Trilho inferior com aba de 34mm	22
CA-113	Contramarco	16	MG32-063	Tubo octogonal de 40 mm	44	RA-013	Remate	20
CA-129	Contramarco	15	MG32-065	Trilho superior correr 04 planos	26	RA-1009	Remate	20
CA-168	Contramarco	18	MG32-066	Trilho inferior correr 04 planos	26	RA-1175	Remate	20
CA-207	Chumbador para CM-063	19	MG32-067	Marco lateral 04 planos	27	RA-347	Remate	20
CA-209	Chumbador para CM-060	19	MG32-068	Tampa interna com 58,6 mm	40	RA-516	Remate	20
CA-517	Contramarco	17	MG32-070	Tampa ext. de 213 mm integrada	40	RA-613	Remate	20
CA-709	Contramarco	17	MG32-072	Marco lateral 3 folhas	24	VA-015	Palheta veneziana 15 mm	45
CA-721	Contramarco	15	MG32-079	Complemento montante central	30	VA-015F	Palheta veneziana 15 mm usinada	45
MG25-292	Baguete porta palheta	46	MG32-083	Trilho inferior correr 2 folhas	22	VA-017	Palheta veneziana 17 mm	45
MG32-001	Trilho inferior da janela com aba	21	MG32-084	Trilho inferior correr 03 folhas	28	VA-017F	Palheta veneziana 17 mm usinada	45
MG32-002	Marco lateral com 02 mata juntas	24	MG32-085	Trilho inferior correr 04 folhas	27	VA-024	Palheta veneziana 9,7 mm	46
MG32-003	Tampa da mata junta	28	MG32-086	Complemento do trilho inferior	32	VA-024F	Palheta veneziana 9,7 mm usinada	46
MG32-004	Trilho inferior da janela com aba	21	MG32-087	Montante lateral da folha	29			
MG32-009	Travessa central da folha	31	MG32-088	Montante central da folha	29			
MG32-010	Marco da folha de giro	36	MG32-090	Montante central interno da folha	29			
MG32-011A	Montante da folha de giro 45°	36	MG32-091	Montante central externo da folha	29			
MG32-012	Baguete	32	MG32-092	Montante bi-tubular central	30			
MG32-013	Trilho superior correr 03 planos	25	MG32-093	Montante bi-tubular central	30			
MG32-014	Marco lateral com 03 mata juntas	25	MG32-094	Montante bi-tubular central	30			
MG32-015	Trilho inferior de correr 03 planos	25	MG32-095	Montante bi-tubular lateral	34			
MG32-016	Marco lateral correr 02 planos	22	MG32-096	Montante bi-tubular central	34			
MG32-017	Trav. sup. bandeira c/02 planos	23	MG32-097	Montante lateral sem baguete	33			
MG32-018	Trav. intermediária sup. do marco	23	MG32-098	Montante central sem baguete	33			
MG32-019	Trav. intermediária inf. do marco	23	MG32-099	Montante central sem baguete	33			
MG32-020	Travessa da folha	31	MG32-100	Montante lateral com reforço	34			
MG32-021	Montante inf. da folha c/ 100 mm	31	MG32-101	Montante central com reforço	34			
MG32-023	Trilho superior de correr 02 planos	21	MG32-102	Montante central com reforço	33			
MG32-024	Mata junta	28	MG32-103	Travessa da folha sem baguete	35			
MG32-025	Baguete	32	MG32-104	Travessa intermediária da folha	35			
MG32-026	Travessa superior da folha de giro	36	MG32-105	Travessa inferior da folha	35			
MG32-027	Baguete	32	MG32-106	Marco superior integrada	41			
MG32-028	Baguete	32	MG32-107	Trilho intermediário 02 folhas	41			
MG32-029	Batedeira da folha de giro	36	MG32-108	Complemento lateral da integrada	43			
MG32-032	Tubo octogonal de 60 mm	44	MG32-109	Tampa externa integrada	42			
MG32-034	Trilho superior da janela integrada	39	MG32-110	Tampa interna integrada	42			
MG32-035	Marco lateral integrada 03 planos	39	MG32-111	Mata junta lateral	28			
MG32-041	Marco superior da caixa integrada	39	MG32-112	Montante central interno	29			

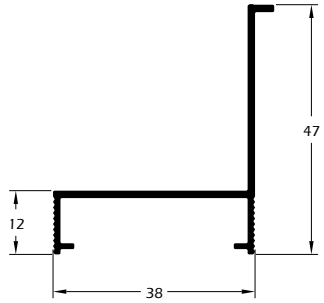
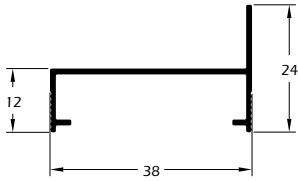

CA-060

0,223 Kg/m

Contramarco

CA-098

0,377 Kg/m

Contramarco

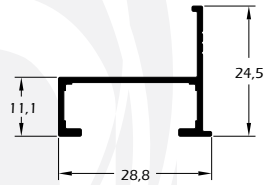
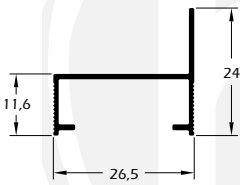

CA-063

0,175 Kg/m

Contramarco

CA-721

0,261 Kg/m

Contramarco

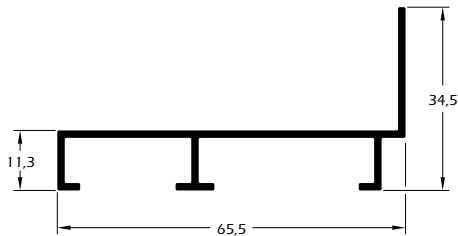

CA-129

0,493 Kg/m

Contramarco

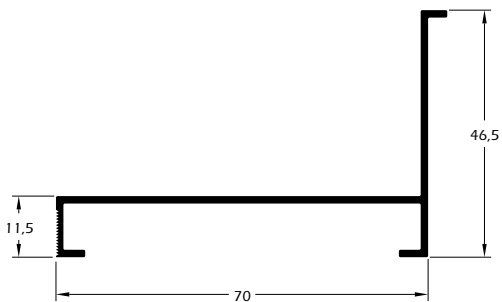

CA-032

0,513 Kg/m

Contramarco

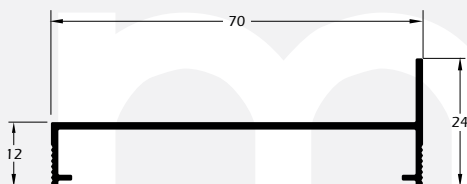

CA-096

0,327 Kg/m

Contramarco

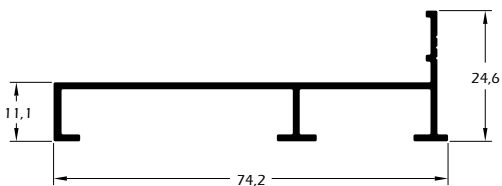

CA-113

0,468 Kg/m

Contramarco

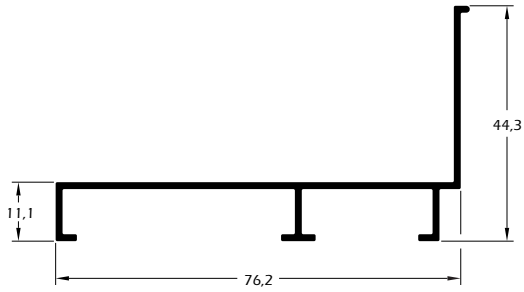

CA-517

0,531 Kg/m

Contramarco

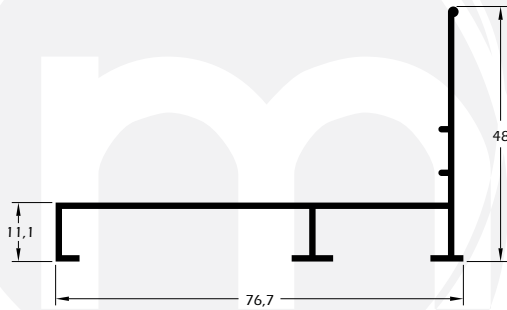

CA-709

0,520 Kg/m

Contramarco

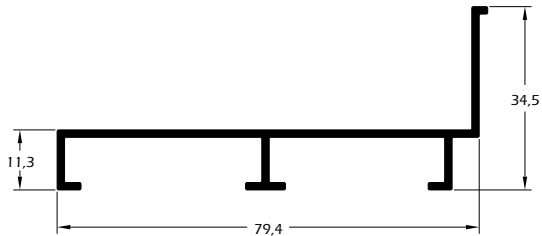

CA-028

0,554 Kg/m

Contramarco

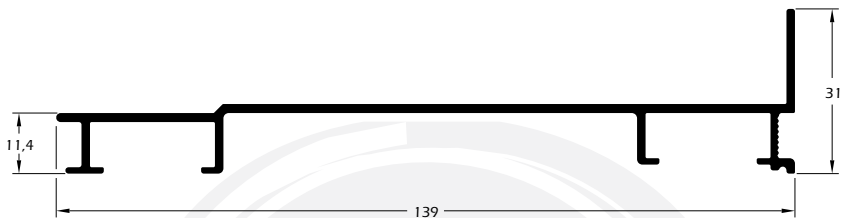

CA-168

0,951 Kg/m

Contramarco

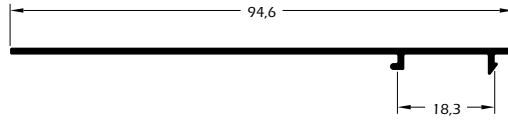

CA-207

0,361 Kg/m

Chumbador para cm-063

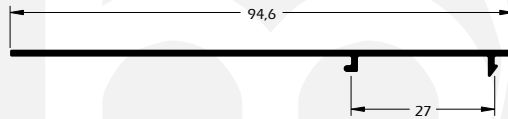

CA-209

0,223 Kg/m

Chumbador para cm-060

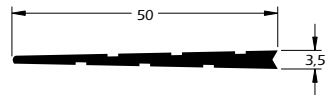
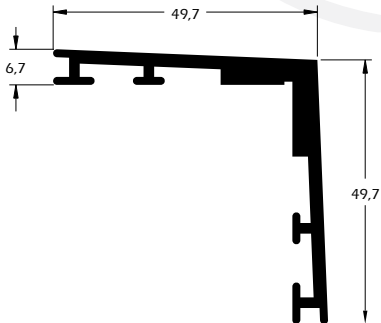

CA-006

1,006 Kg/m

Macho de conexão

CA-011

0,315 Kg/m

Cunha de conexão

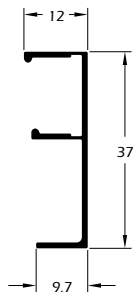

RA-347

0,197 Kg/m

Remate

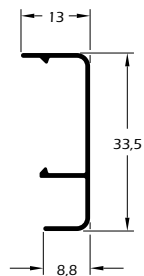

RA-613

0,162 Kg/m

Remate

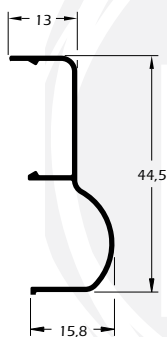

RA-1009

0,209 Kg/m

Remate

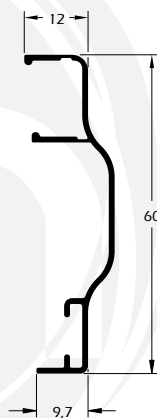

RA-1175

0,297 Kg/m

Remate

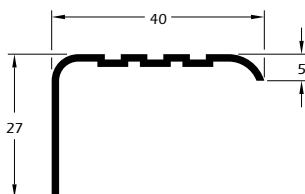

RA-013

0,268 Kg/m

Remate

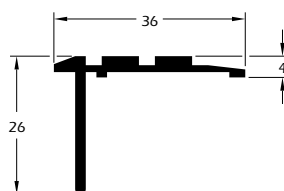

RA-516

0,339 Kg/m

Remate

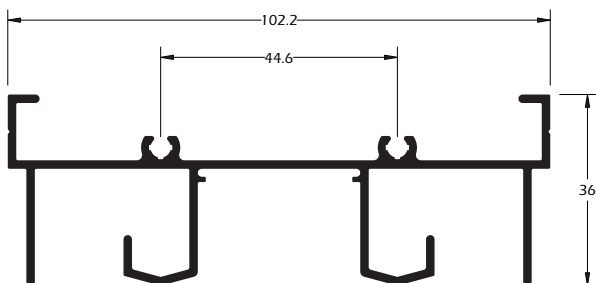

MG32-001 1,230 Kg/m Trilho superior de correr 02 planos

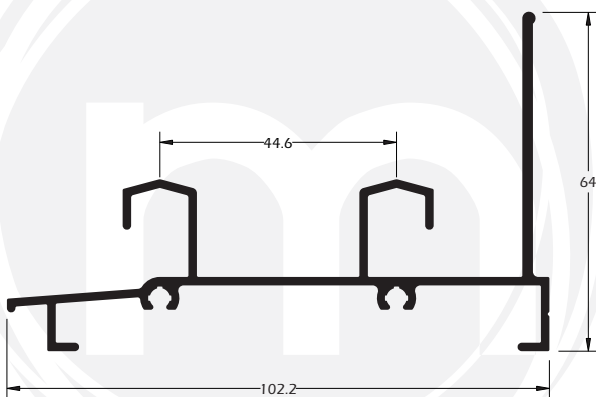

MG32-004 1,123 Kg/m Trilho inferior da janela com aba de 64 mm correr 02 planos

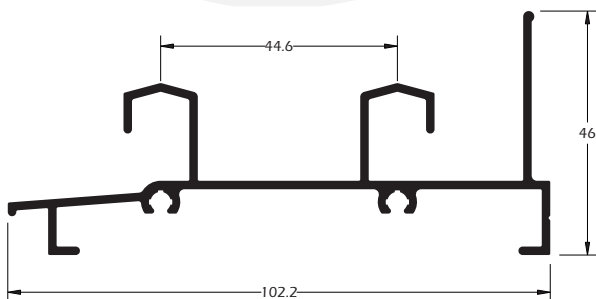

MG32-023 1,256 Kg/m Trilho inferior da janela com aba de 46 mm correr 02 planos

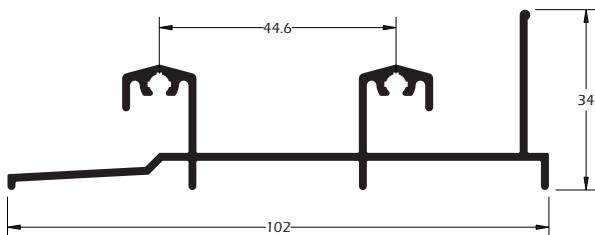

MG32-610 | 0,957 Kg/m | Trilho inferior com aba de 34mm

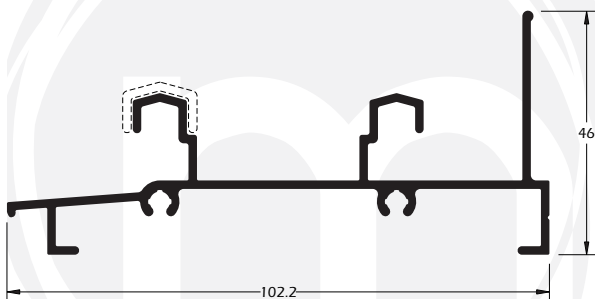

MG32-083 | 1,088 Kg/m | Trilho inferior correr 2 folhas

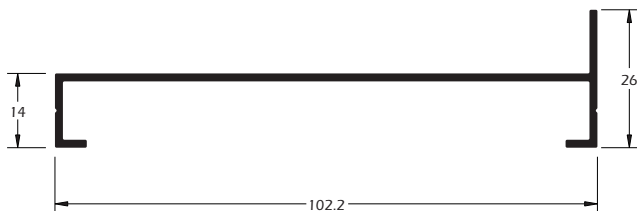

MG32-016 | 0,601 Kg/m | Marco lateral correr 02 planos

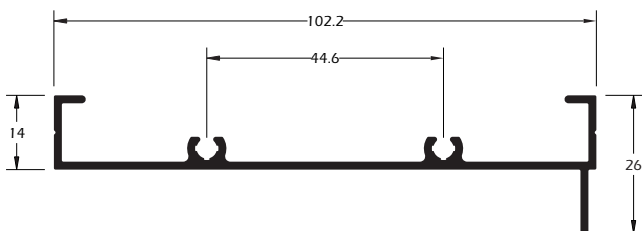

MG32-017

0,708 Kg/m

Travessa superior da bandeira
com 02 planos

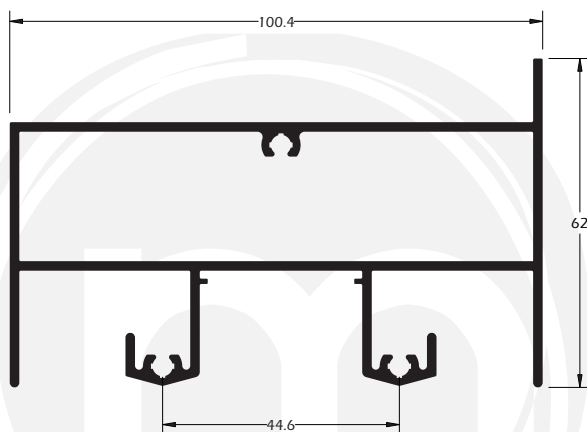

MG32-018

1,999 Kg/m

Travessa intermediária superior
do marco correr 02 planos

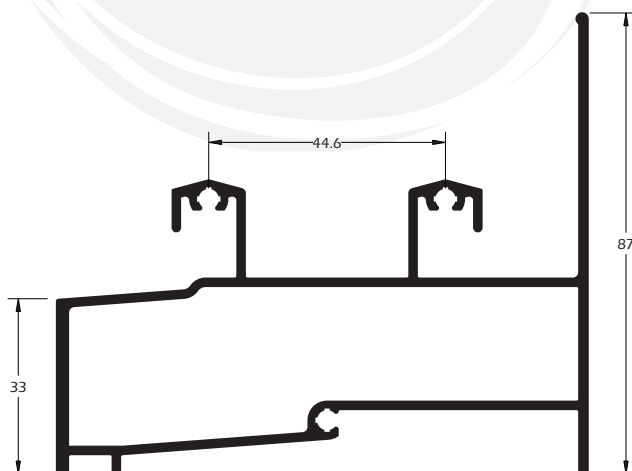

MG32-019

1,115 Kg/m

Travessa intermediária inferior
do marco correr 02 planos

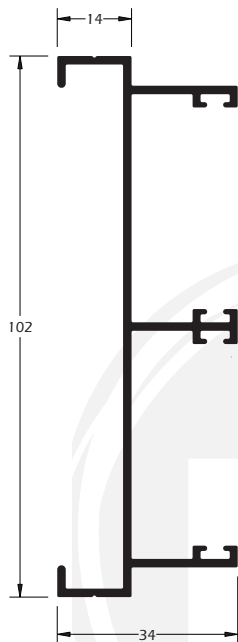

MG32-002 | 0,952 Kg/m | Marco lateral com 02 mata juntas correr 02 planos

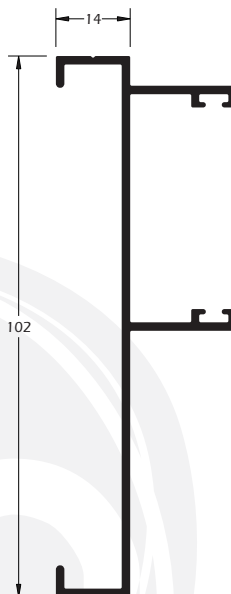

MG32-049 | 0,812 Kg/m | Marco lateral com 01 mata junta correr 02 planos

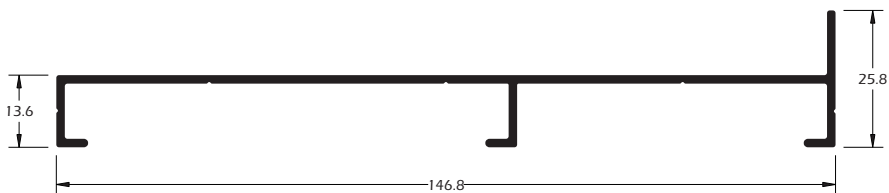

MG32-072 | 0,887 Kg/m | Marco lateral 3 folhas

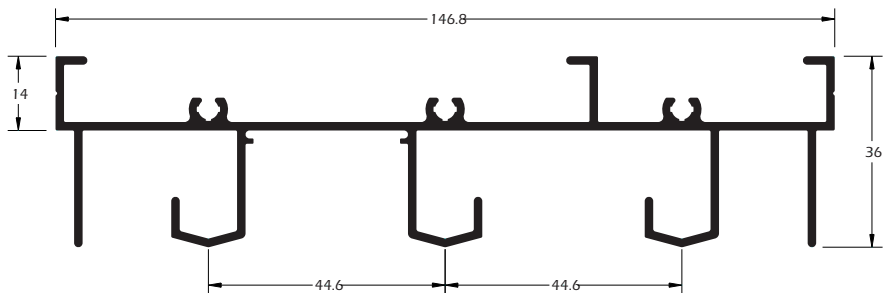

MG32-013 1,718 Kg/m Trilho superior correr 03 planos

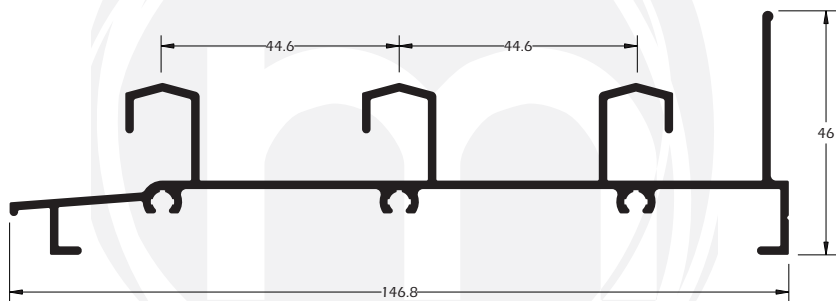

MG32-015 1,524 Kg/m Trilho inferior de correr 03 planos

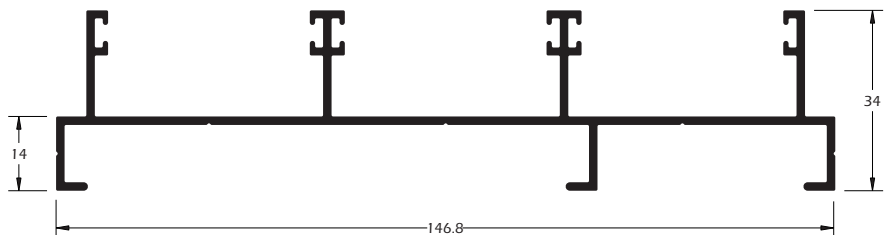

MG32-014 1,357 Kg/m Marco lateral com 03 mata juntas correr 03 planos

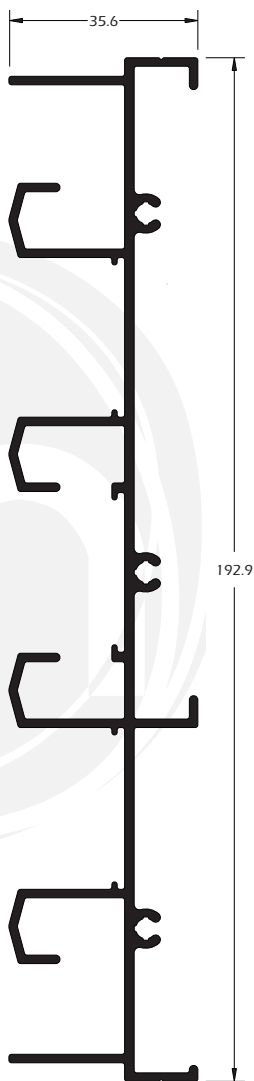
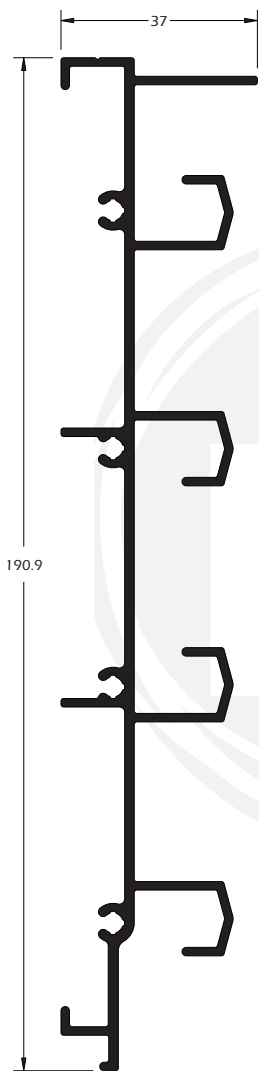

MG32-066

1,967 Kg/m

Trilho inferior correr 04 planos

MG32-065

2,117 Kg/m

Trilho superior correr 04 planos

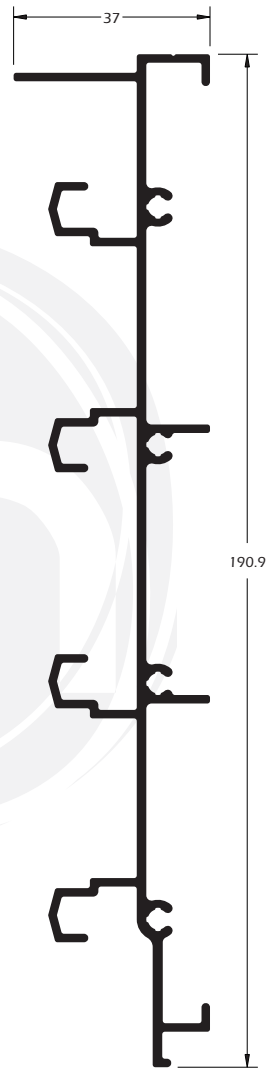
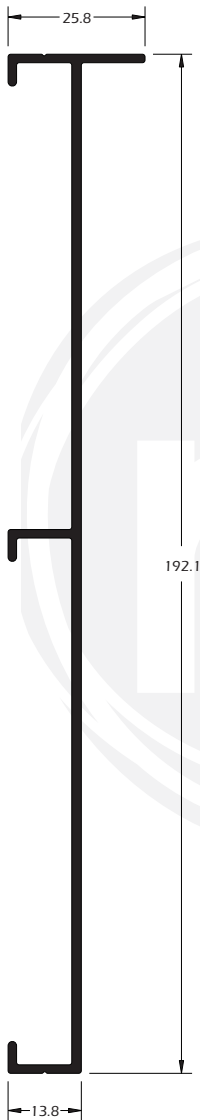

MG32-067

1,163 Kg/m

Marco lateral 04 planos

MG32-085

1,979 Kg/m

Trilho inferior correr 04 folhas

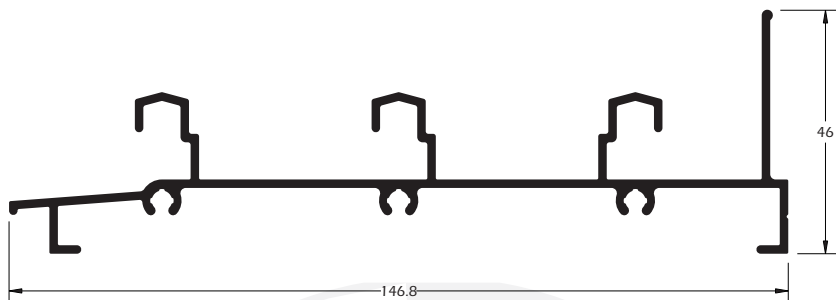

MG32-084 | 1,470 Kg/m | Trilho inferior correr 03 folhas

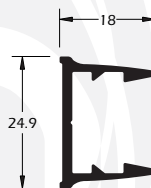
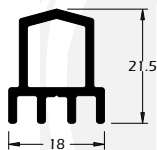

MG32-052 | 0,318 Kg/m | Trilho único

MG32-111 | 0,282 Kg/m | Mata junta lateral

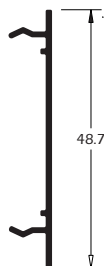
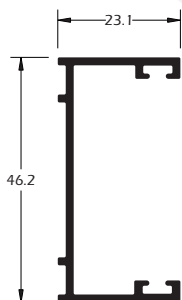

MG32-024 | 0,430 Kg/m | Mata junta

MG32-003 | 0,206 Kg/m | Tampa da mata junta

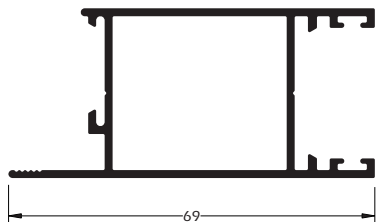

MG32-087

0,843 Kg/m

Montante lateral da folha

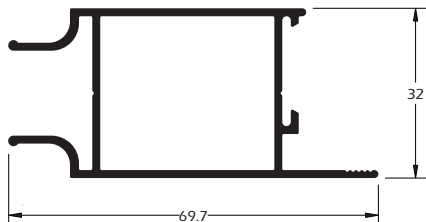

MG32-088

0,825 Kg/m

Montante central da folha

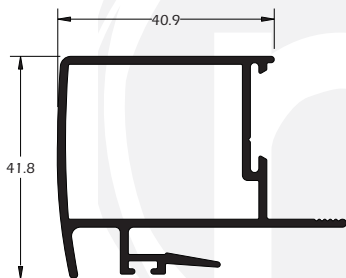

MG32-090

0,806 Kg/m

Montante central interno da folha
com mão de amigo

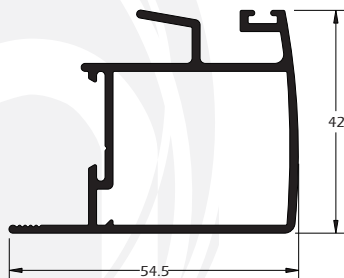

MG32-112

0,815 Kg/m

Montante central interno

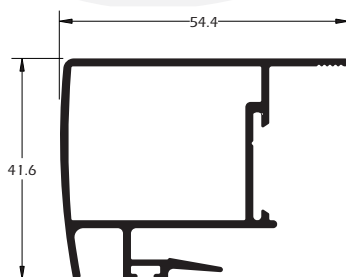

MG32-091

0,808 Kg/m

Montante central externo da folha
com mão de amigo

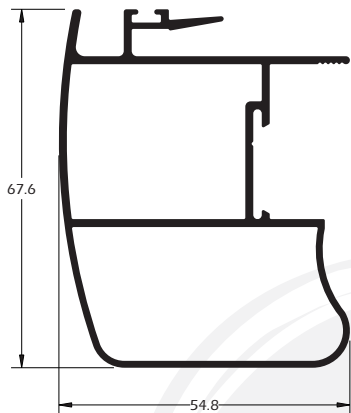

MG32-092 1,185 Kg/m Montante bi-tubular acabado central interno da folha

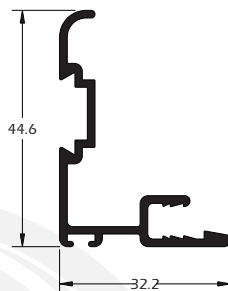

MG32-079 0,450 Kg/m Complemento do montante central para fixar na parede

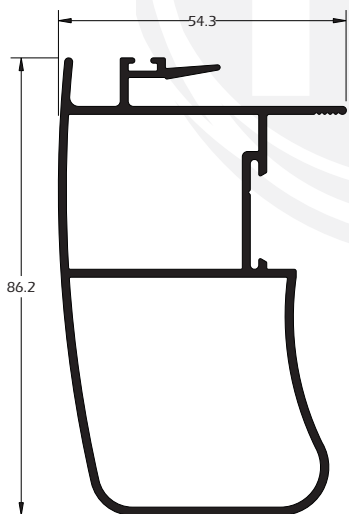

MG32-093 1,331 Kg/m Montante bi-tubular acabado central interno da folha

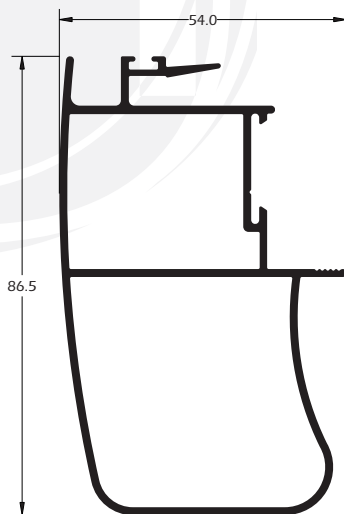

MG32-094 1,331 Kg/m Montante bi-tubular acabado central externo da folha

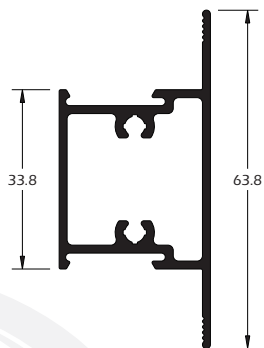
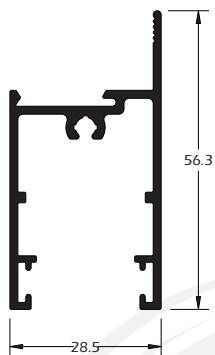

MG32-020

0,647 Kg/m

Travessa da folha

MG32-009

0,750 Kg/m

Travessa central da folha

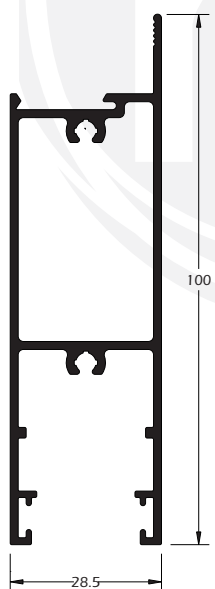

MG32-021

1,161 Kg/m

Montante inferior da
folha com 100 mm

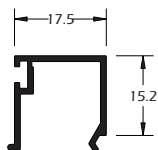

MG32-012 0,173 Kg/m Baguete

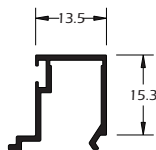

MG32-025 0,155 Kg/m Baguete

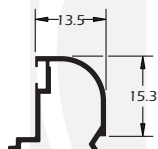

MG32-028 0,141 Kg/m Baguete

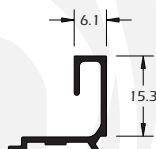

MG32-027 0,142 Kg/m Baguete

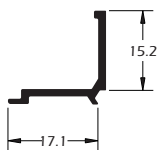

MG32-028 0,141 Kg/m Baguete



MG32-086 0,114 Kg/m Complemento do trilho inferior

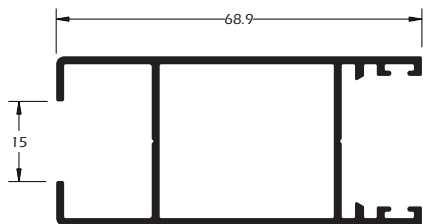

MG32-097 0,922 kg/m Montante lateral sem baguete

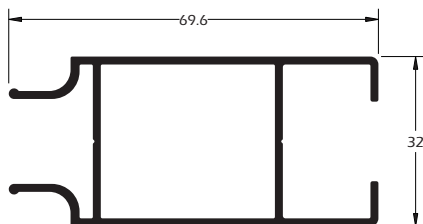

MG32-098 0,904 kg/m Montante central sem baguete

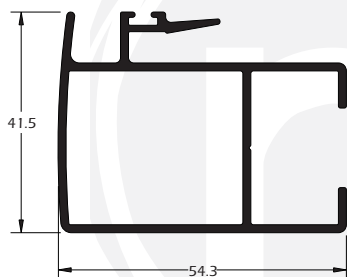

MG32-099 0,886 Kg/m Montante central sem baguete

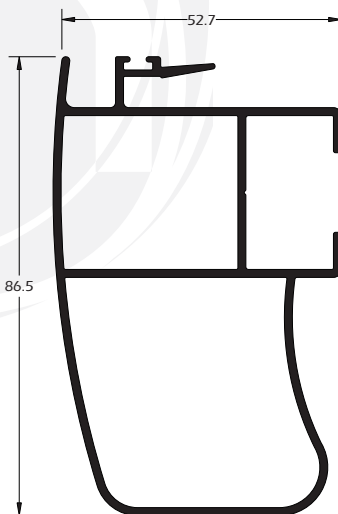

MG32-102 1,399 Kg/m Montante central com reforço sem baguete

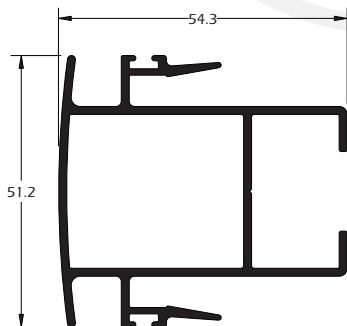

MG32-113 1,050 Kg/m Montante central duplo

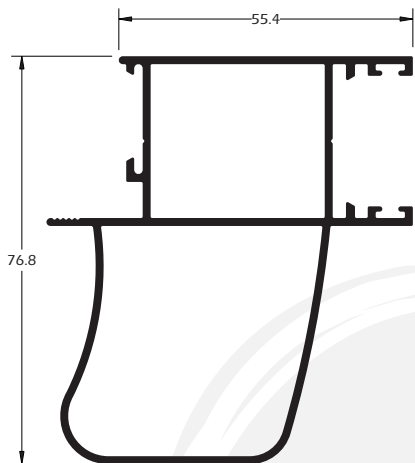

MG32-095 1,574 Kg/m Montante bi-tubular acabado lateral da folha

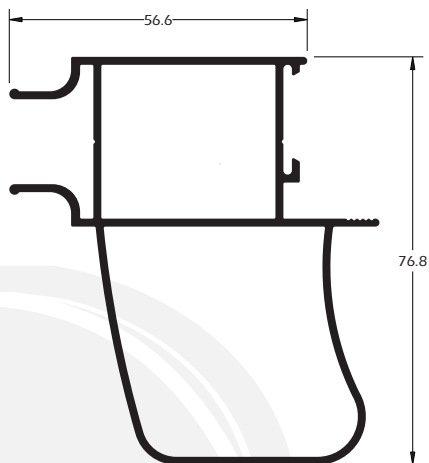

MG32-096 1,335 Kg/m Montante bi-tubular acabado central da folha

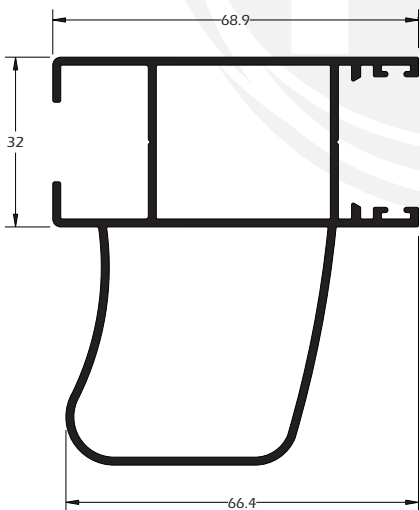

MG32-100 1,433 Kg/m Montante lateral com reforço sem baguete

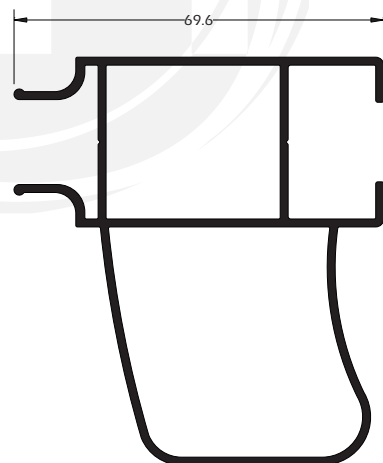

MG32-101 1,415 Kg/m Montante central com reforço sem baguete

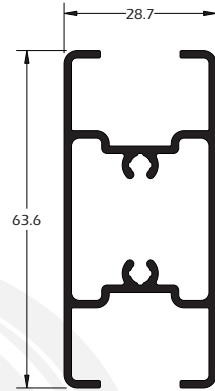
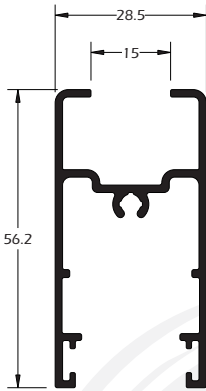

MG32-103

0,682 Kg/m

Travessa da folha sem baguete

MG32-104

0,868 Kg/m

Travessa intermediária da folha sem baguete

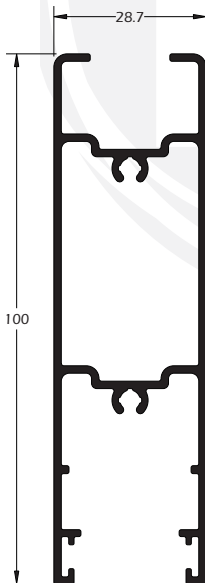

MG32-105

1,180 Kg/m

Travessa inferior da folha sem baguete

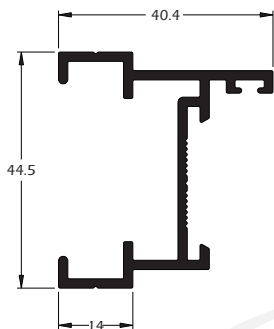

MG32-010 | 0,658 Kg/m | Marco da folha de giro

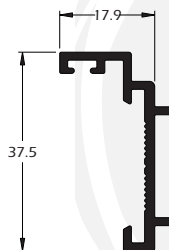

MG32-029 | 0,342 Kg/m | Batedeira da folha de giro

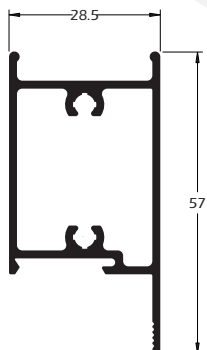

MG32-026 | 0,750 Kg/m | Travessa superior da folha de giro

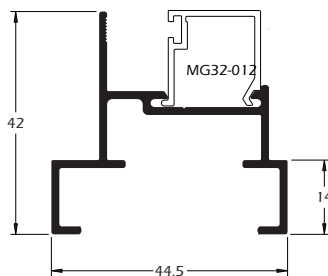

MG32-051 | 0,549 Kg/m | Marco do fixo

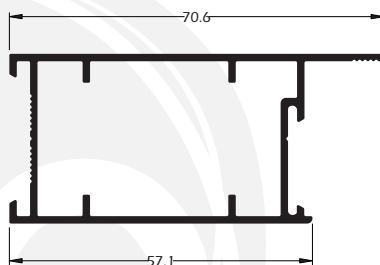

MG32-011A | 0,810 Kg/m | Montante da folha de giro 45° com 70 mm

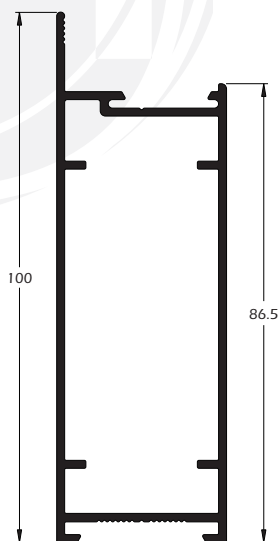

MG32-047 | 0,949 Kg/m | Montante da folha de giro 45° com 100 mm

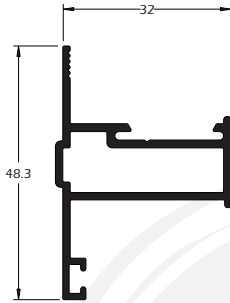

MG32-157

0,537 Kg/m

Montante perimetral

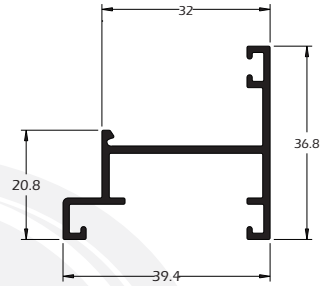

MG32-174

0,417 Kg/m

Marco perimetral

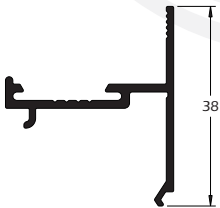

MG32-175

0,328 Kg/m

Reversor do marco

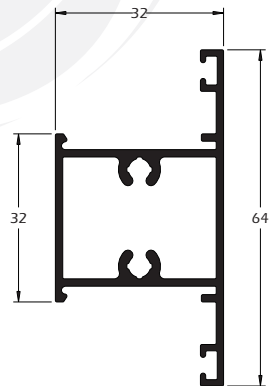

MG32-158

0,781 Kg/m

Travessa do marco

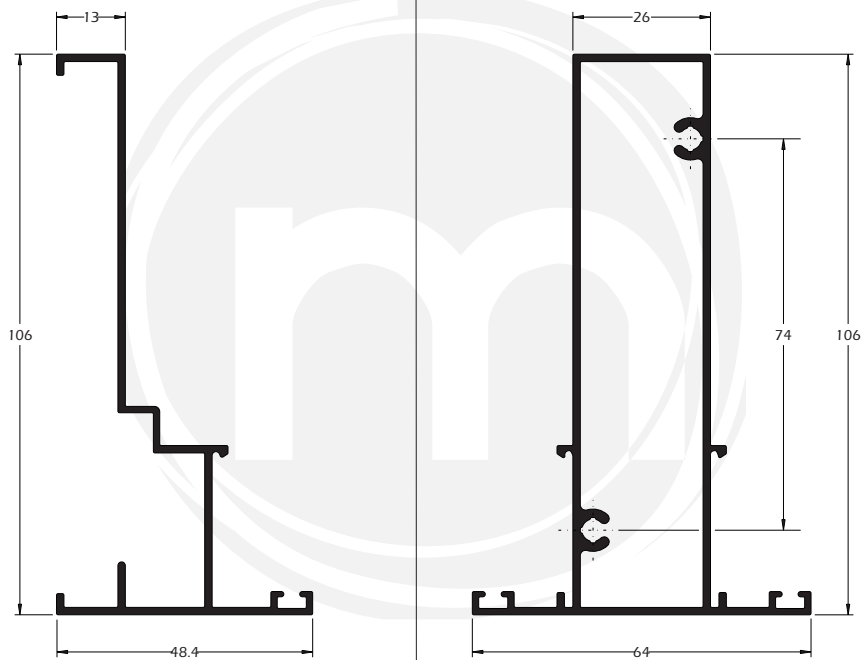

MG32-173

0,766 Kg/m

Travessa do marco

MG32-159

1,342 Kg/m

Coluna do marco

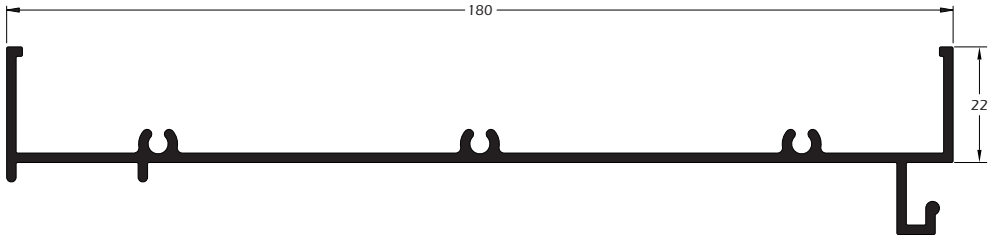

MG32-041 1,274 Kg/m Marco superior da caixa integrada 03 planos

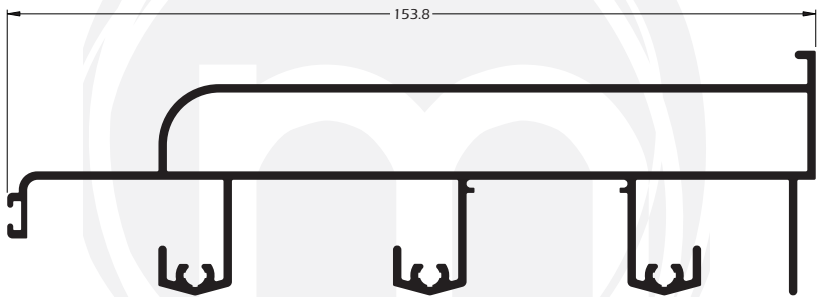

MG32-034 2,142 Kg/m Trilho superior da janela integrada 03 planos

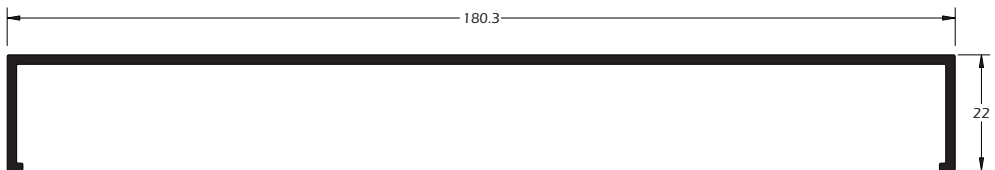

MG32-035 1,085 Kg/m Marco lateral da integrada 03 planos

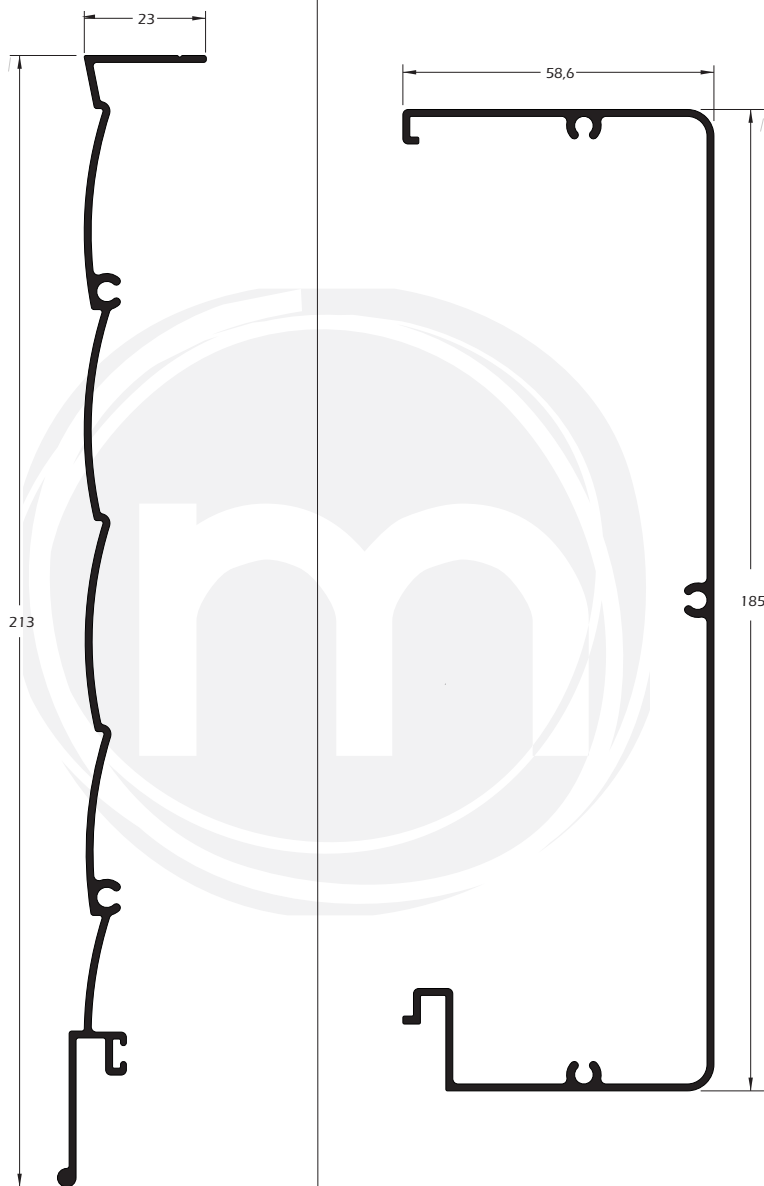

MG32-070

1,005 Kg/m

Tampa externa de 213 mm integrada

MG32-068

1,214 Kg/m

Tampa interna com 58,6 mm sobressalente da caixa integrada

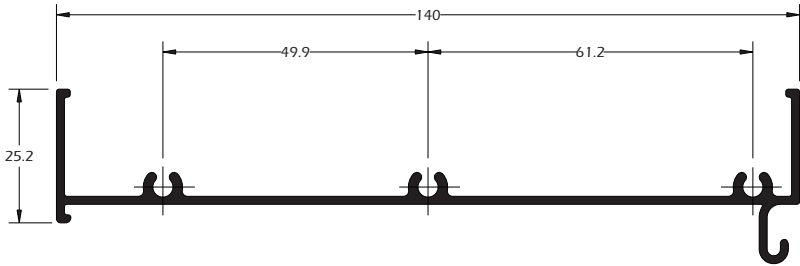

MG32-106 0,969 Kg/m Marco superior integrada

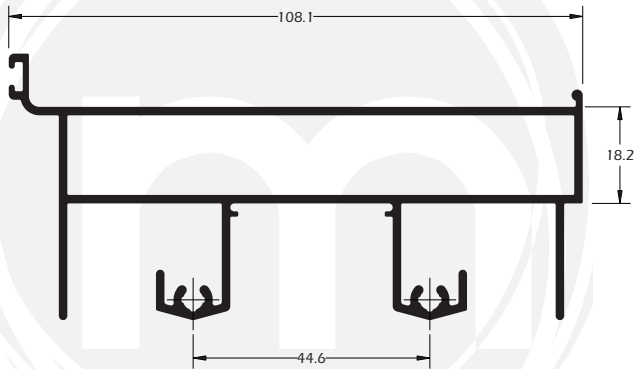

MG32-107 1,714 Kg/m Trilho intermediário 02 folhas integrada

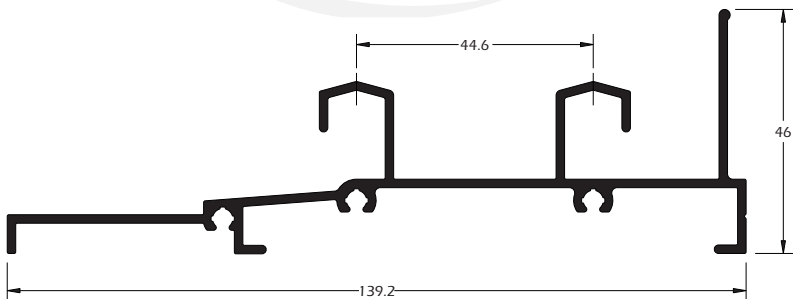

MG32-061 1,332 Kg/m Trilho inferior da janela integrada 02 planos

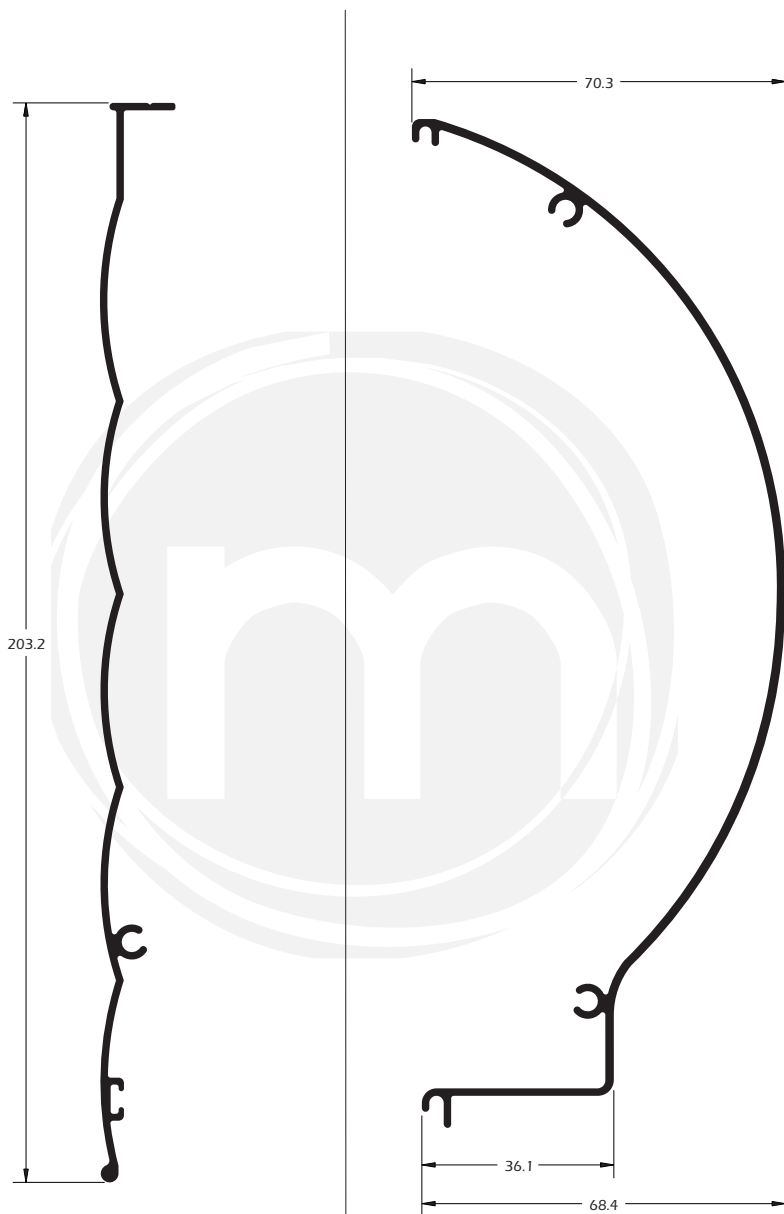

MG32-109 | 0,922 Kg/m | Tampa externa integrada

MG32-110 | 1,274 Kg/m | Tampa interna integrada

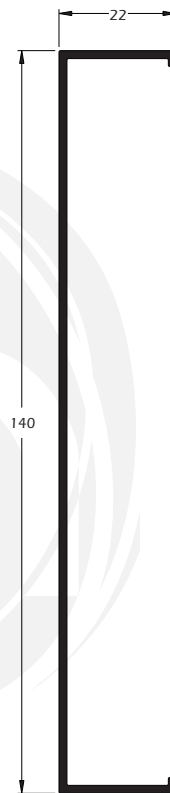
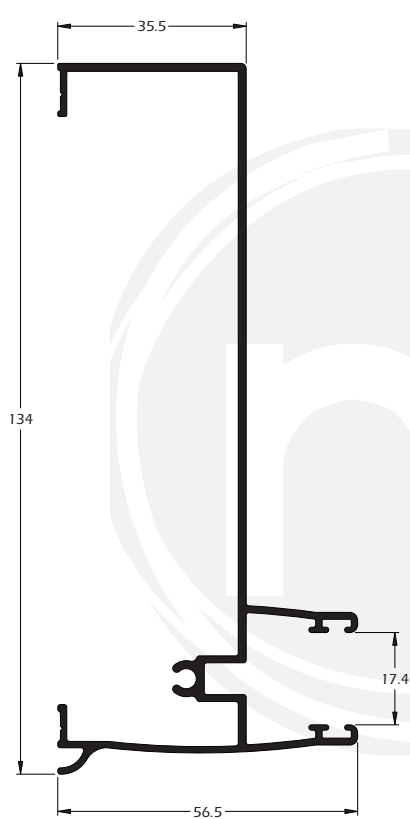

MG32-108 1,148 Kg/m Complemento lateral da integrada

MG32-059 1,017 Kg/m

Marco superior da caixa integrada 02 planos

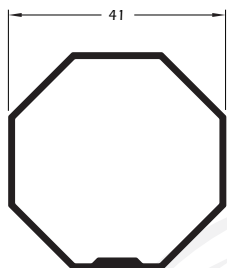

MG32-063 | 0,489 Kg/m | Tubo octogonal de 40 mm

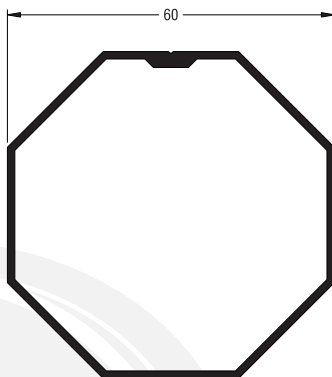

MG32-032 | 0,792 Kg/m | Tubo octogonal de 60 mm

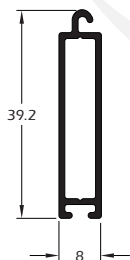

MG32-062 | 0,270 Kg/m | Lamina contra-peso de 39,2 mm

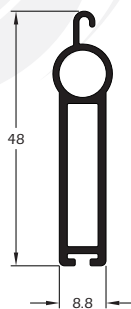

MG32-046 | 0,430 Kg/m | Lamina contra-peso de 48 mm

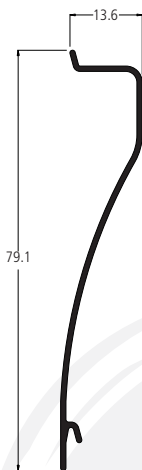

VA-015

0,265 Kg/m

Palheta veneziana 15 mm

VA-015F

0,265 Kg/m

Palheta veneziana 15 mm usinada



VA-017

0,274 Kg/m

Palheta veneziana 17 mm

VA-017F

0,274 Kg/m

Palheta veneziana 17 mm usinada

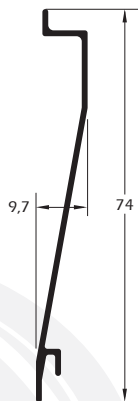
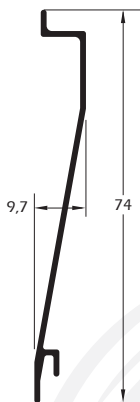

VA-024

0,271 Kg/m

Palheta veneziana 9,7 mm

VA-024F

0,271 Kg/m

Palheta veneziana 9,7 mm usinada

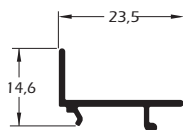

MG25-292

0,142 Kg/m

Baguete porta palheta



ACESSÓRIOS

Índice de acessórios

código	descrição	pág.	código	descrição	pág.
CHU-00787	Chumbador para contramarcos (natural)	58	GUIA 10005PTO	Guia limitadora (preta)	51
CONC00496BRO	Fecho conha (branco)	49	NYLO00369BCO	Guia e limitador da persiana (branca)	63
CONC00496PTO	Fecho conha (preto)	49	NYLO00369PTO	Guia e limitador da persiana (preta)	63
CONT00383BCO	Fecho automático para porta (branco)	50	NYLO00370BCO	Guia da persiana em poliamida (branco)	61
CONT00383PTO	Fecho automático para porta (preto)	50	NYLO00370PTO	Guia da persiana em poliamida (preto)	61
FECH01127BCO	Fecho manual (branco)	49	NYLO00395BCO	Vedação inferior (branca)	53
FECH01127BRO	Fecho conha (branco)	50	NYLO00395PTO	Vedação inferior (preta)	53
FECH01127PTO	Fecho manual (preto)	49	NYLO00398BCO	Batedeira (branca)	51
FECH01127PTO	Fecho conha (preto)	50	NYLO00398PTO	Batedeira (preta)	51
FECH01128BCO	Fecho manual (branco)	50	NYLO00420BCO	Botão tapa furo (branco)	56
FECH01128PTO	Fecho manual (preto)	50	NYLO00420PTO	Botão tapa furo (preto)	56
FECH01129BCO	Fecho autom. (branco)	49	NYLO00447BCO	Tampa lateral da palheta (branca)	59
FECH01129PTO	Fecho autom. (preto)	49	NYLO00447PTO	Tampa lateral da palheta (preta)	59
FECH01130BCO	Fecho autom. (branco)	50	NYLO00738BCO	Limitador de abertura (branco)	63
FECH01130PTO	Fecho autom. (preto)	50	NYLO00738PTO	Limitador de abertura (preto)	63
FECH10007BCO	Fecho automático para janela (branco)	49	NYLO0190PTO	Presilha do arremate	57
FECH10007BZE	Fecho automático para janela (bronze)	49	Palheta	Esteira montada	59
FECH10007FCO	Fecho automático para janela (fosco)	49	PRE00965PTO	Presilha do arremate	57
FECH10007PTO	Fecho automático para janela (preto)	49	REC-120	Recolhedor Ø 118 (preto)	62
FITASB05X06BCO	Fita vedadora s/ barreira plástica 5 x 6 mm	64	REC-120 EB	Recolhedor Ø 118 (branco)	62
FITASB07X08BCO	Fita vedadora s/ barreira plástica 7 x 8 mm	64	REC-121	Recolhedor Ø 136 (preto)	62
FITO007490	Mola de segurança para fixação da esteira	61	REC-121 EB	Recolhedor Ø 136 (branco)	62
GUAR00256PTO	Guarnição em EPDM (Vidro de 4 e 6 mm)	65	REC-122	Recolhedor Ø 118 (preto)	62
GUAR00256PTO	Guarnição em EPDM (Vidro de 6 mm)	68	REC-122 EB	Recolhedor Ø 118 (branco)	62
GUAR00259PTO	Guarnição em EPDM (Vidro de 6, 8 e 10 mm)	65	REC-123	Recolhedor Ø 136 (preto)	62
GUAR00259PTO	Guarnição em EPDM (Vidro de 4 mm)	68	REC-123 EB	Recolhedor Ø 136 (branco)	62
GUAR00259PTO	Guarnição em EPDM (Vidro de 6 mm)	68	ROLD00414FCO	Roldana dupla com rolamento e regulagem	52
GUAR00259PTO	Guarnição em EPDM (Vidro de 8 mm)	68	ROLD00468FCO	Roldana simples c/ rolamento e regulagem (preta)	52
GUAR00259PTO	Guarnição em EPDM (Vidro de 10 mm)	68	TAMP10014BCO	Tampa lateral da janela c/persiana (branca)	55
GUAR00303PTO	Guarnição em EPDM (Vidro de 17 e 20 mm)	66	TAMP10014PTO	Tampa lateral da janela c/persiana (preta)	55
GUAR00304PTO	Guarnição em EPDM (Vidro de 4 e 6 mm)	67	TAMP10016BCO	Tampa lateral da janela c/persiana (branca)	55
GUAR00304PTO	Guarnição em EPDM (Vidro de 8 mm)	67	TAMP10016PTO	Tampa lateral da janela c/persiana (preta)	55
GUAR00306PTO	Guarnição em EPDM (Vidro de 6 e 10 mm)	67	TAMP10018BCO	Tampa lateral da porta com persiana (branca)	56
GUAR00385PTO	Guarnição em EPDM (Vidro de 3 e 4 mm)	66	TAMP10018PTO	Tampa lateral da porta com persiana (preta)	56
GUAR00386PTO	Guarnição em EPDM (Vidro de 5 e 6 mm)	66	TAMP10019BCO	Tampa do montante (branca)	54
GUIA 10002BCO	Guia da cinta do recolhedor (branca)	60	TAMP10019PTO	Tampa do montante (preta)	54
GUIA 10002PTO	Guia da cinta do recolhedor (preta)	60	TAMP10020BCO	Tampa do montante (branca)	54
GUIA 10003BCO	Guia central da persiana em poliamida (branca)	60	TAMP10020PTO	Tampa do montante (preta)	54
GUIA 10003PTO	Guia central da persiana em poliamida (preta)	60	VEDA00381BCO	Vedação superior (branca)	53
GUIA 10005CTO	Guia limitadora (branca)	51	VEDA00381PTO	Vedação superior (preta)	53

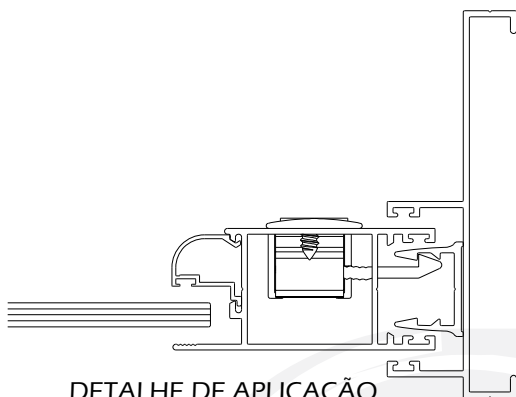

DETALHE DE APLICAÇÃO
sem escala

Código	Descrição
FECH10007PTO	Fecho automático para janela (preto)
FECH10007FCO	Fecho automático para janela (fosco)
FECH10007BZE	Fecho automático para janela (bronze)
FECH10007BCO	Fecho automático para janela (branco)

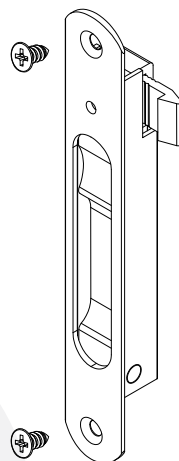

PERSPECTIVA
sem escala

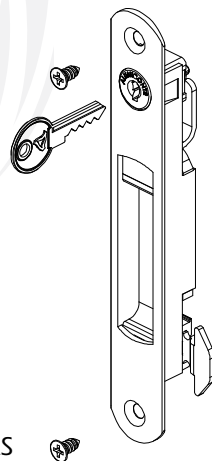
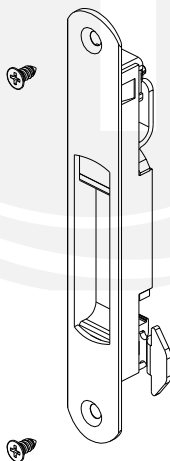
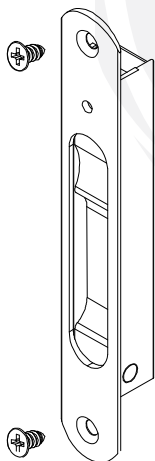

PERSPECTIVAS
sem escala

Código	Descrição
CONC00496PTO	Fecho conha (preto)
CONC00496BRO	Fecho conha (branco)

Código	Descrição
FECH01127PTO	Fecho manual (preto)
FECH01127BCO	Fecho manual (branco)

Código	Descrição
FECH01129PTO	Fecho autom. (preto)
FECH01129BCO	Fecho autom. (branco)

Código (ver tabela)

Fechos para janela

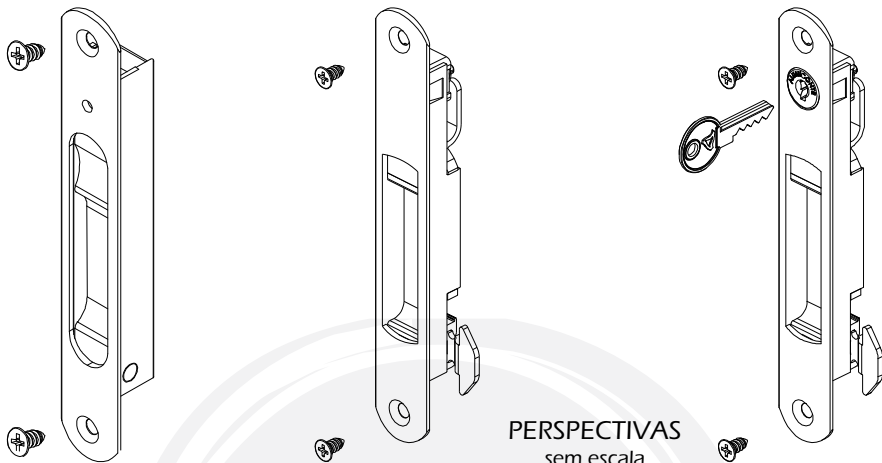

PERSPECTIVAS
sem escala

Código	Descrição
FECH01127PTO	Fecho conha (preto)
FECH01127BCO	Fecho conha (branco)

Código	Descrição
FECH01128PTO	Fecho manual (preto)
FECH01128BCO	Fecho manual (branco)

Código	Descrição
FECH01130PTO	Fecho autom. (preto)
FECH01130BCO	Fecho autom. (branco)

Código (ver tabela)

Fechos para porta

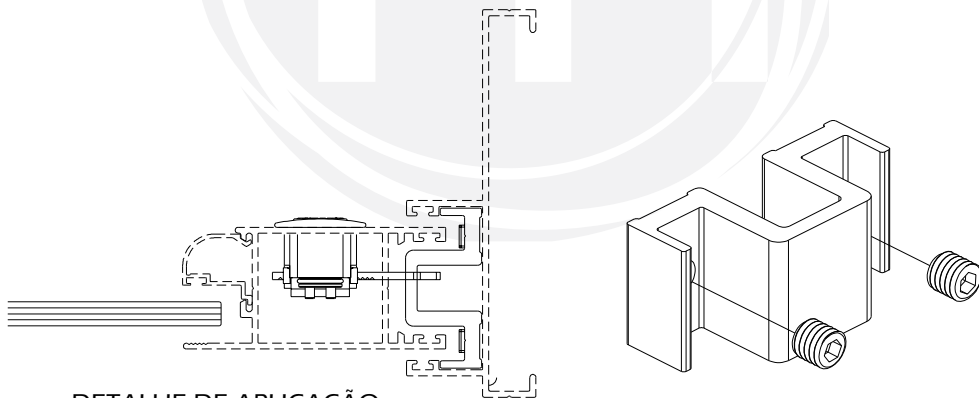

DETALHE DE APLICAÇÃO
sem escala

PERSPECTIVA
sem escala

Código	Descrição
CONT00383PTO	Fecho automático para porta (preto)
CONT00383BCO	Fecho automático para porta (branco)

Código (ver tabela)

Contra fecho para porta

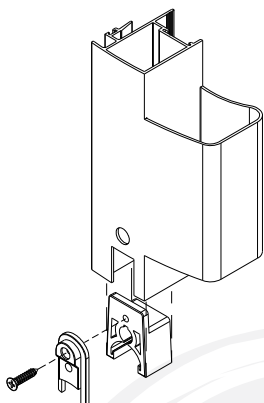

DETALHE DE APLICAÇÃO
sem escala

Código	Descrição
GUIA10005PTO	Guia limitadora (preta)
GUIA10005CTO	Guia limitadora (branca)

Código (ver tabela) Guia limitadora

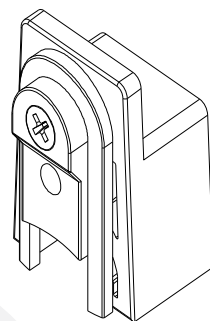

PERSPECTIVA
sem escala

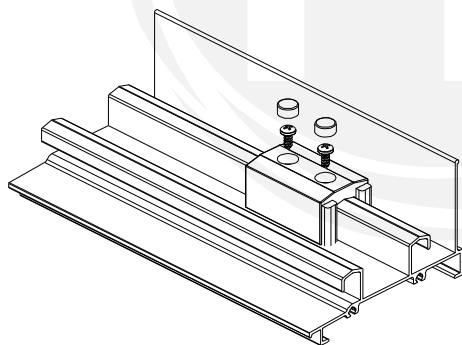

DETALHE DE APLICAÇÃO
sem escala

Código	Descrição
NYLO00398PTO	Batedeira (preta)
NYLO00398BCO	Batedeira (branca)

Código (ver tabela) Batedeira

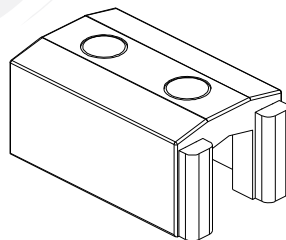

PERSPECTIVA
sem escala

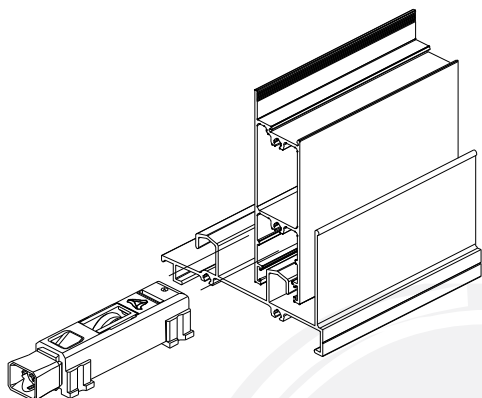

DETALHE DE APLICAÇÃO
sem escala

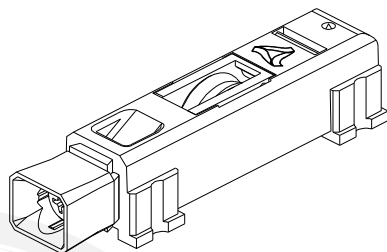

PERSPECTIVA
sem escala

ROLD00468FCO

Roldana simples com rolamento e regulagem (preta)

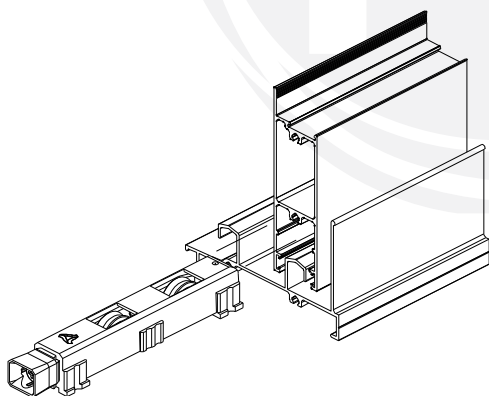

DETALHE DE APLICAÇÃO
sem escala

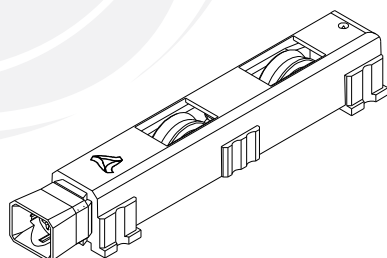

PERSPECTIVA
sem escala

ROLD00414FCO

Roldana dupla com rolamento e regulagem

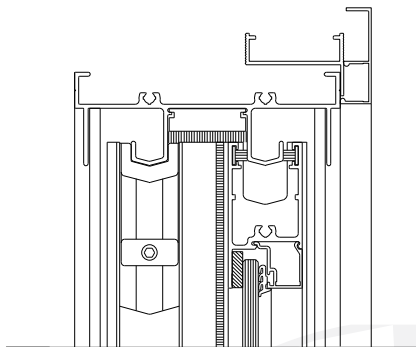

DETALHE DE APLICAÇÃO
sem escala

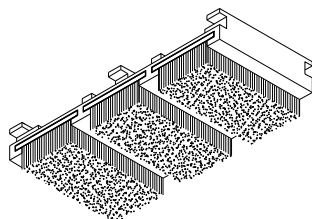

PERSPECTIVA
sem escala

Código	Descrição
VEDA00381PTO	Vedação superior (preta)
VEDA00381BCO	Vedação superior (branca)

Código (ver tabela)	Vedação superior
---------------------	------------------

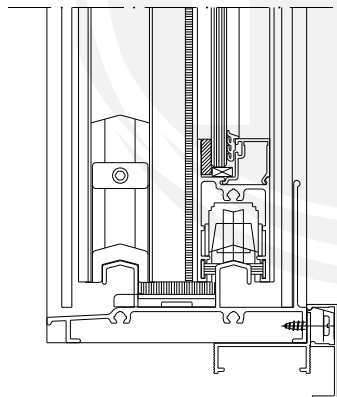

DETALHE DE APLICAÇÃO
sem escala

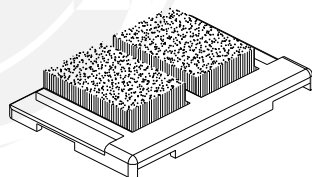

PERSPECTIVA
sem escala

Código	Descrição
NYLO00395PTO	Vedação inferior (preta)
NYLO00395BCO	Vedação inferior (branca)

Código (ver tabela)	Vedação inferior
---------------------	------------------

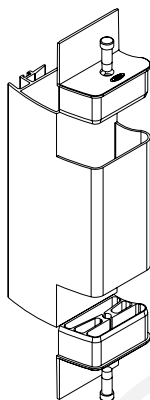

DETALHE DE APLICAÇÃO
sem escala

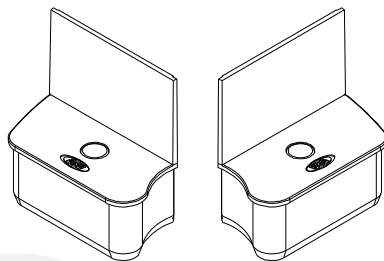

PERSPECTIVA
sem escala

Código	Descrição
TAMP10019PTO	Tampa do montante (preta)
TAMP10019BCO	Tampa do montante (branca)

Código (ver tabela)

Tampa do montante inferior e superior

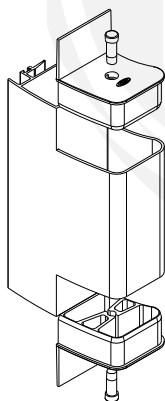

DETALHE DE APLICAÇÃO
sem escala

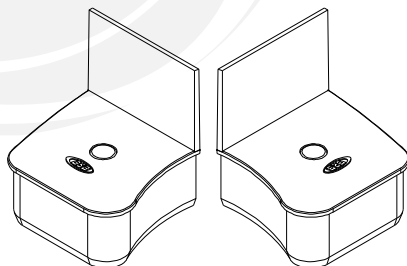

PERSPECTIVA
sem escala

Código	Descrição
TAMP10020PTO	Tampa do montante (preta)
TAMP10020BCO	Tampa do montante (branca)

Código (ver tabela)

Tampa do montante inferior e superior

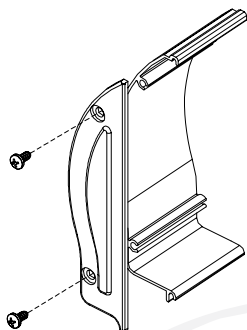

DETALHE DE APLICAÇÃO
sem escala

Código	Descrição
TAMP10014PTO	Tampa lateral da janela c/persiana (preta)
TAMP10014BCO	Tampa lateral da janela c/persiana (branca)

Código (ver tabela) | Tampa lat. da janela c/persiana integrada

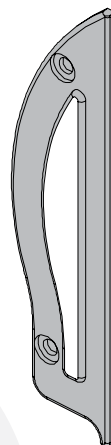

PERSPECTIVA
sem escala

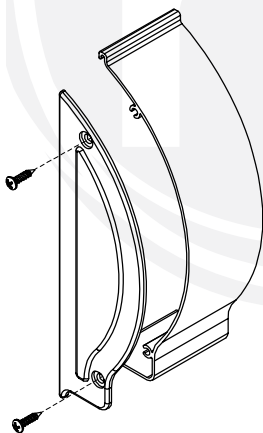

DETALHE DE APLICAÇÃO
sem escala

Código	Descrição
TAMP10016PTO	Tampa lateral da janela c/persiana (preta)
TAMP10016BCO	Tampa lateral da janela c/persiana (branca)

Código (ver tabela) | Tampa lat. da janela c/persiana integrada

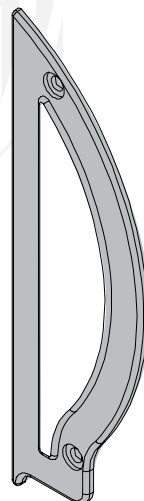

PERSPECTIVA
sem escala

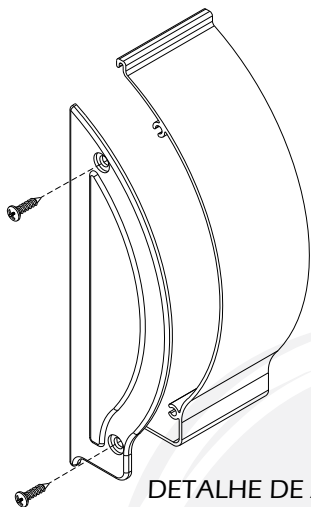

DETALHE DE APLICAÇÃO
sem escala

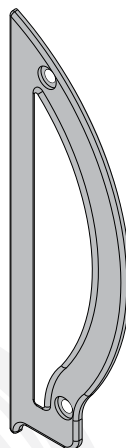

PERSPECTIVA
sem escala

Código	Descrição
TAMP10018PTO	Tampa lateral da porta com persiana (preta)
TAMP10018BCO	Tampa lateral da porta com persiana (branca)

Código (ver tabela)

Tampa lat. da porta com persiana integrada

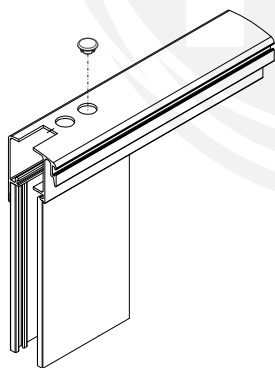

DETALHE DE APLICAÇÃO
sem escala

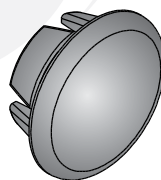

PERSPECTIVA
sem escala

Código	Descrição
NYLO00420PTO	Botão tampa furo (preto)
NYLO00420BCO	Botão tampa furo (branco)

Código (ver tabela)

Botão tampa furo

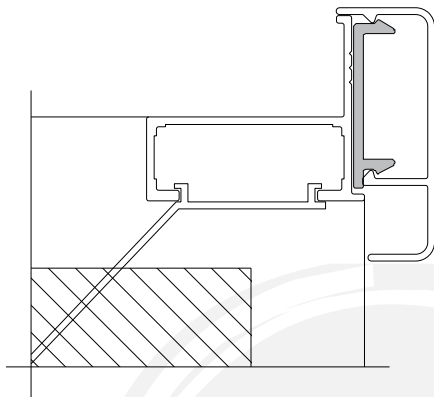

DETALHE DE APLICAÇÃO
sem escala

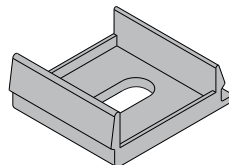

PERSPECTIVA
sem escala

PREO0965PTO

Presilha do arremate

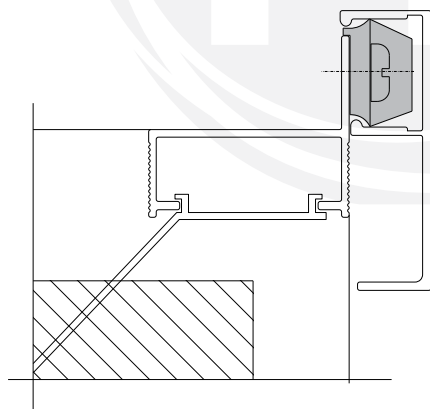

DETALHE DE APLICAÇÃO
sem escala

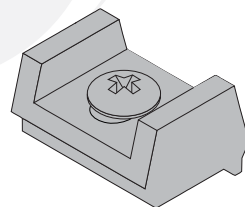

PERSPECTIVA
sem escala

NYLO0190PTO

Presilha do arremate

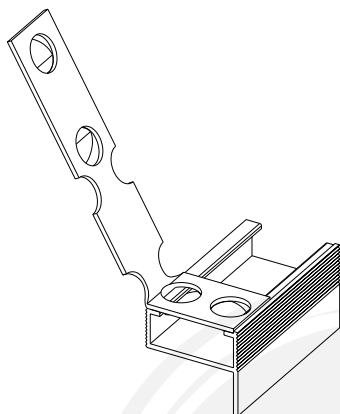

DETALHE DE APLICAÇÃO
sem escala

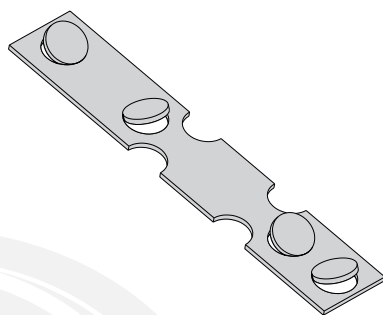

PERSPECTIVA
sem escala

CHU-00787

Chumbador para contramarcos (natural)

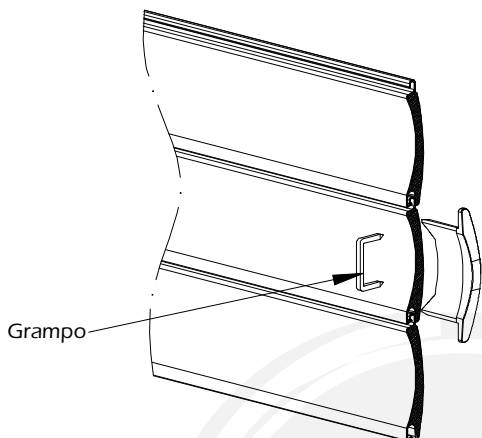

DETALHE DE APLICAÇÃO
sem escala

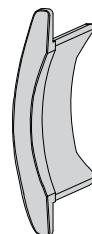

PERSPECTIVA
sem escala

Código	Descrição
NYLO00447PTO	Tampa lateral da palheta (preta)
NYLO00447BCO	Tampa lateral da palheta (branca)

Código (ver tabela)	Tampa lateral da palheta
---------------------	--------------------------

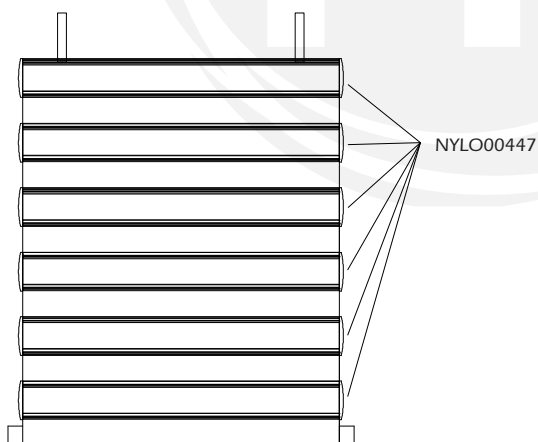

DETALHE DE APLICAÇÃO
sem escala

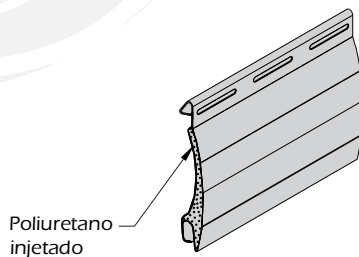

PERSPECTIVA
sem escala

Palheta	Esteira montada
---------	-----------------

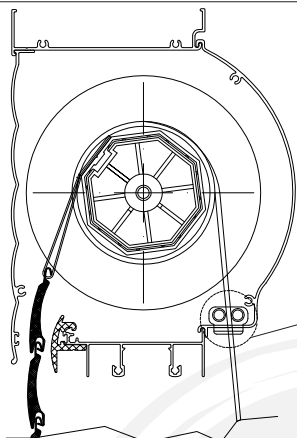

DETALHE DE APLICAÇÃO
sem escala

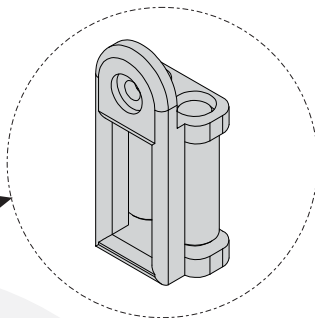

PERSPECTIVA
sem escala

Código	Descrição
GUIA10002PTO	Guia da cinta do recolhedor (preta)
GUIA10002BCO	Guia da cinta do recolhedor (branca)

Código (ver tabela)

Guia da cinta do recolhedor em poliamida

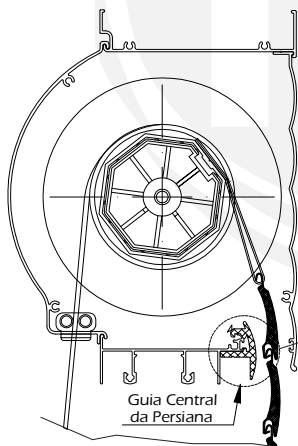

DETALHE DE APLICAÇÃO
sem escala

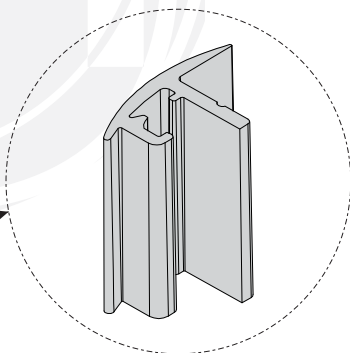

PERSPECTIVA
sem escala

Código	Descrição
GUIA10003PTO	Guia central da persiana em poliamida (preta)
GUIA10003BCO	Guia central da persiana em poliamida (branca)

Código (ver tabela)

Guia central da persiana em poliamida

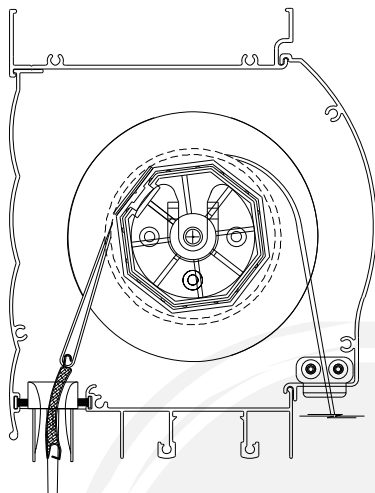

DETALHE DE APLICAÇÃO
sem escala

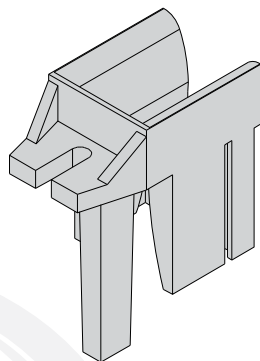

PERSPECTIVA
sem escala

Código	Descrição
NYLO00370PTO	Guia da persiana em poliamida (preto)
NYLO00370BCO	Guia da persiana em poliamida (branco)

Código (ver tabela)

Guia da persiana em poliamida

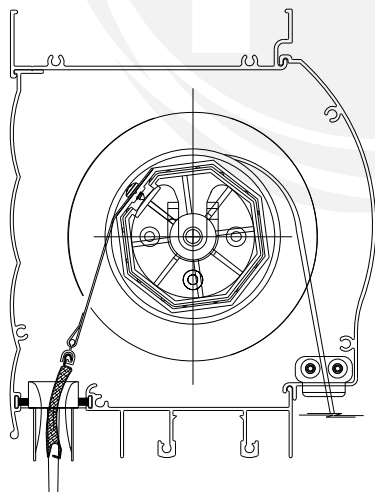

DETALHE DE APLICAÇÃO
sem escala

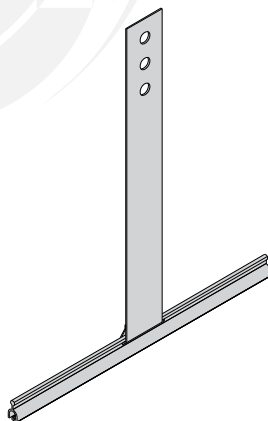

PERSPECTIVA
sem escala

FITO007490

Mola de segurança para fixação da esteira

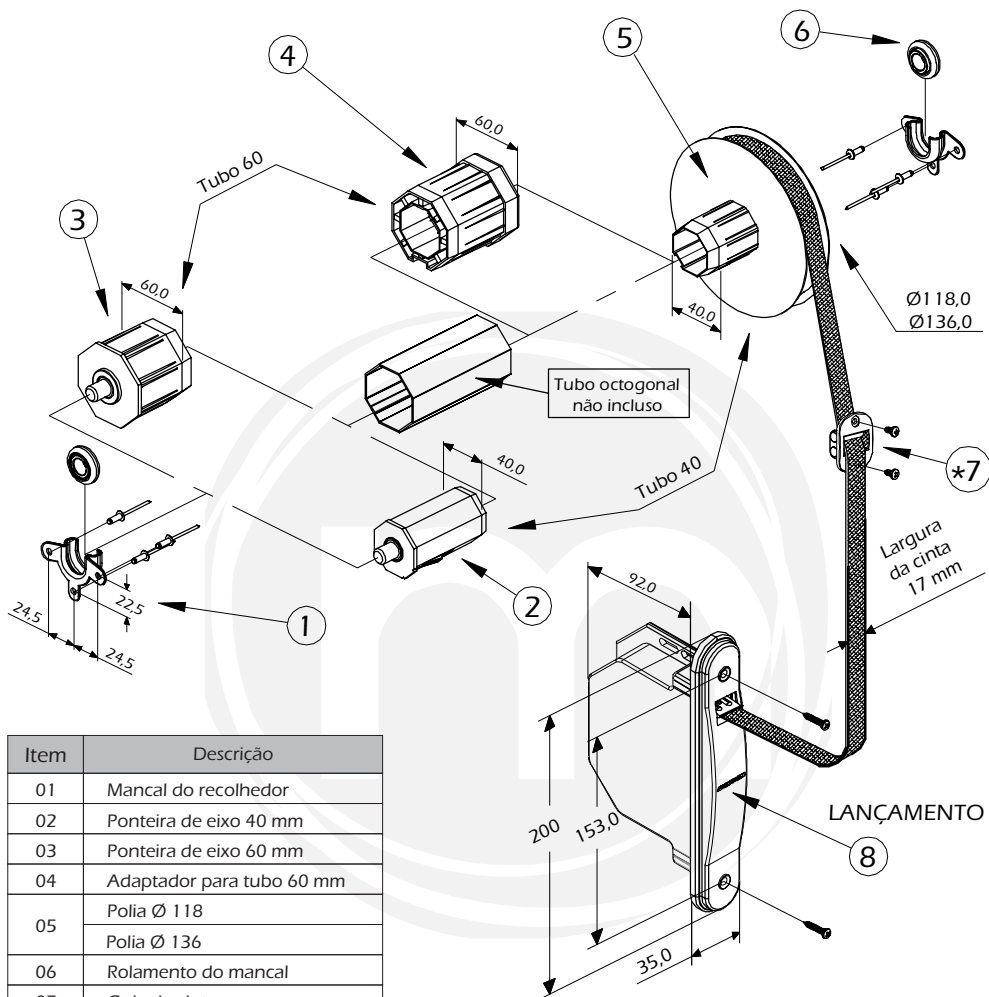

Item	Descrição
01	Mancal do recolhedor
02	Ponteira de eixo 40 mm
03	Ponteira de eixo 60 mm
04	Adaptador para tubo 60 mm
05	Polia Ø 118
	Polia Ø 136
06	Rolamento do mancal
07	Guia da cinta
08	Máquina com espelho e caixa

Código (preto)	Código (branco)	Tubo (mm)	Polia (mm)	Aplicação
REC-120	REC-120 EB	40	Ø 118	Janela
REC-121	REC-121 EB	40	Ø 136	Porta
REC-122	REC-122 EB	60	Ø 118	Janela
REC-123	REC-123 EB	60	Ø 136	Porta

Código (ver tabela)

Recolhedor

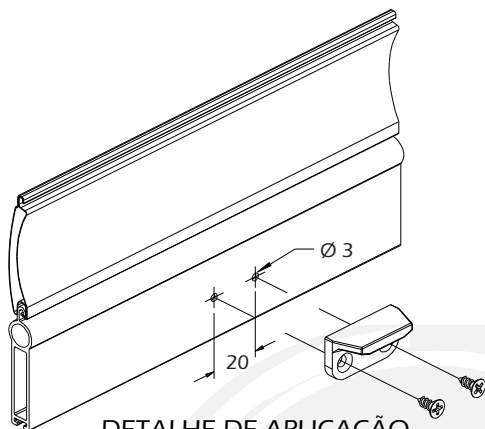

DETALHE DE APLICAÇÃO
sem escala

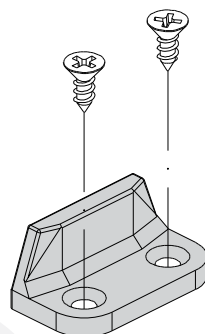

PERSPECTIVA
sem escala

Código	Descrição
NYLO00738PTO	Limitador de abertura (preto)
NYLO00738BCO	Limitador de abertura (branco)

Código (ver tabela)	Limitador de abertura
---------------------	-----------------------

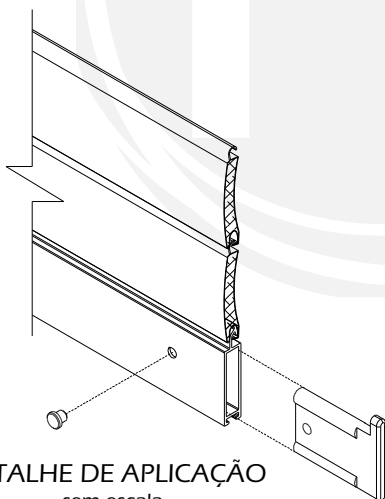

DETALHE DE APLICAÇÃO
sem escala

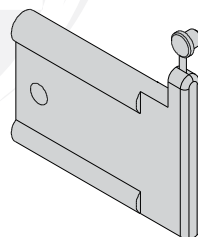

PERSPECTIVA
sem escala

Código	Descrição
NYLO00369PTO	Guia e limitador da persiana (preta)
NYLO00369BCO	Guia e limitador da persiana (branca)

NYLO00369	Guia e limitador da persiana
-----------	------------------------------

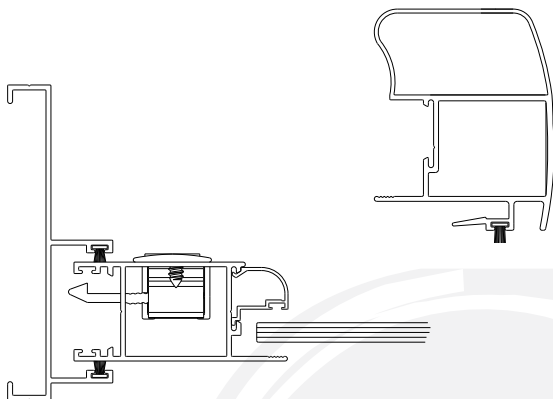

DETALHES DE APLICAÇÃO
sem escala

FITASB05X06BCO

Fita vedadora s/ barreira plástica 5 x 6 mm

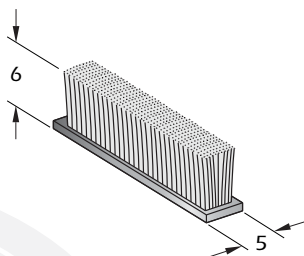

PERSPECTIVA
sem escala

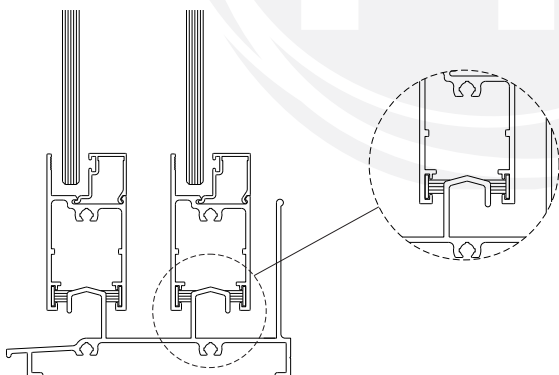

DETALHES DE APLICAÇÃO
sem escala

FITASB07X08BCO

Fita vedadora s/ barreira plástica 7 x 8 mm

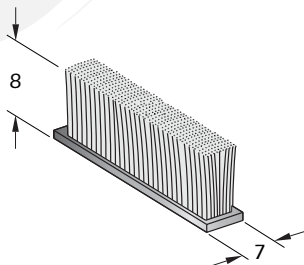

PERSPECTIVA
sem escala

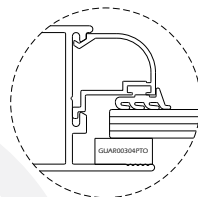
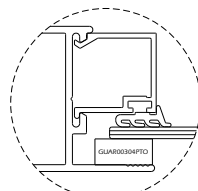
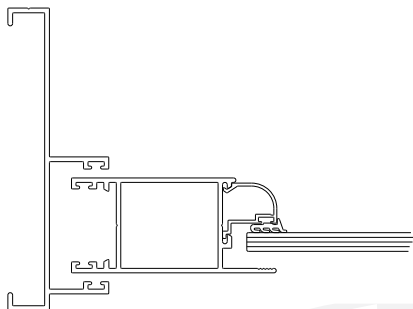

Código	Descrição
GUAR00256PTO	Guarnição em EPDM (Vidro de 4mm) + GUAR00304PTO
	Guarnição em EPDM (Vidro de 6mm) + GUAR00304PTO

DETALHE DE APLICAÇÃO
sem escala

Código (ver tabela)	Guarnição em EPDM (preta)
---------------------	---------------------------

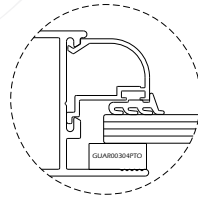
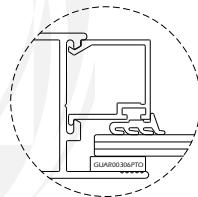
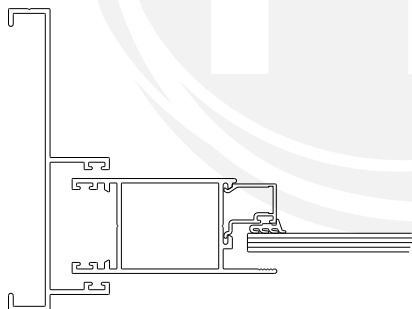

Código	Descrição
GUAR00259PTO	Guarnição em EPDM (Vidro de 6mm) + GUAR00306PTO
	Guarnição em EPDM (Vidro de 8mm) + GUAR00304PTO
	Guarnição em EPDM (Vidro de 10mm) + GUAR00306PTO

DETALHE DE APLICAÇÃO
sem escala

Código (ver tabela)	Guarnição em EPDM (preta)
---------------------	---------------------------

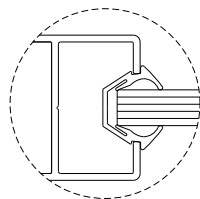
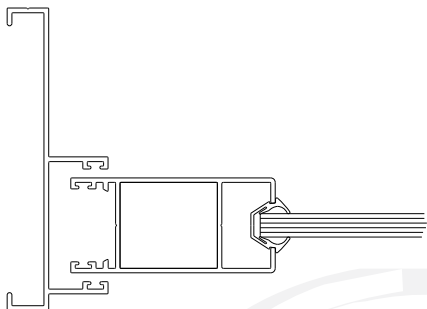

Código	Descrição
GUAR00385PTO	Guarnição em EPDM (Vidro 3 mm)
	Guarnição em EPDM (Vidro 4 mm)
GUAR00386PTO	Guarnição em EPDM (Vidro 5 mm)
	Guarnição em EPDM (Vidro 6 mm)
Código (ver tabela)	Guarnição em EPDM (preta)

DETALHE DE APLICAÇÃO
sem escala

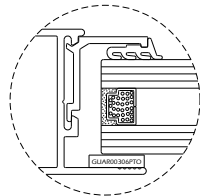
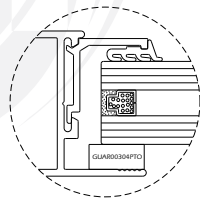
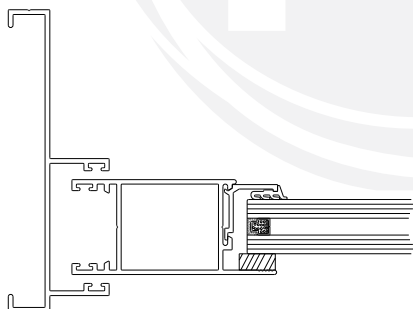

Código	Descrição
GUAR00303PTO	Guarnição em EPDM (Vidro de 20mm) + GUAR00306PTO
	Guarnição em EPDM (Vidro de 17mm) + GUAR00304PTO
Código (ver tabela)	Guarnição em EPDM (preta)

DETALHE DE APLICAÇÃO
sem escala

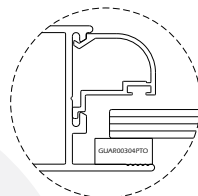
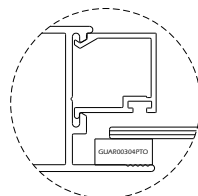
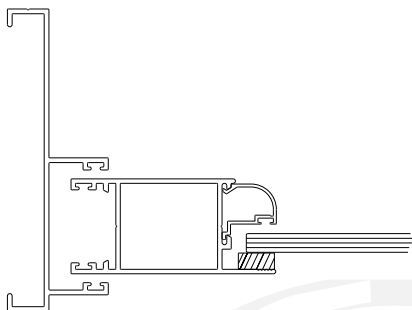

Código	Descrição
GUAR00304PTO	Guarnição em EPDM (Vidro de 4mm) + GUAR00256PTO
	Guarnição em EPDM (Vidro de 6mm) + GUAR00256PTO

DETALHES DE APLICAÇÃO
sem escala

Código (ver tabela)	Guarnição em EPDM (preta)
---------------------	---------------------------

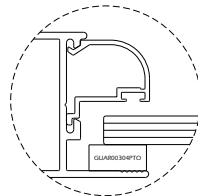
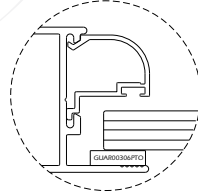
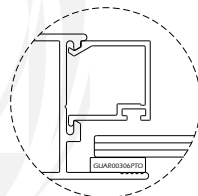
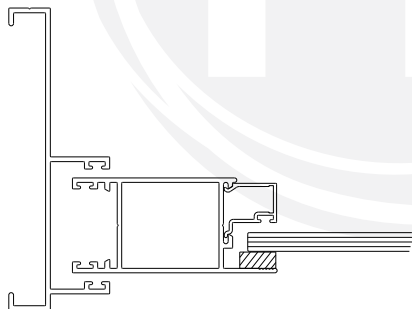

Código	Descrição
GUAR00306PTO	Guarnição em EPDM (Vidro de 6 mm)
	Guarnição em EPDM (Vidro de 10 mm)
GUAR00304PTO	Guarnição em EPDM (Vidro de 8 mm)

DETALHES DE APLICAÇÃO
sem escala

Código (ver tabela)	Guarnição em EPDM (preta)
---------------------	---------------------------

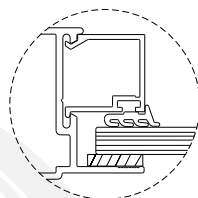
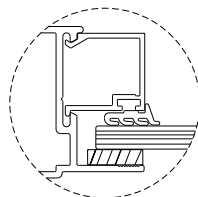
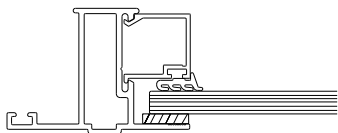

Código	Descrição
GUAR00259PTO	Guarnição em EPDM (Vidro de 4mm) + GUAR00304PTO
	Guarnição em EPDM (Vidro de 6mm) + GUAR00306PTO

Código (ver tabela)

Guarnição em EPDM (preta)

DETALHES DE APLICAÇÃO
sem escala

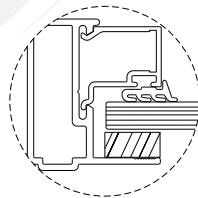
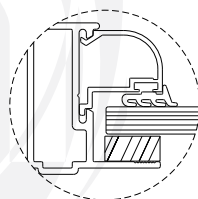
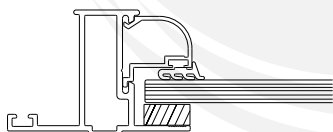

Código	Descrição
GUAR00256PTO	Guarnição em EPDM (Vidro de 6mm) + GUAR00304PTO
GUAR00259PTO	Guarnição em EPDM (Vidro de 8mm) + GUAR00304PTO
	Guarnição em EPDM (Vidro de 10 mm) + GUAR00306PTO

Código (ver tabela)

Guarnição em EPDM (preta)

DETALHES DE APLICAÇÃO
sem escala



GRÁFICOS

Central 4 Folhas

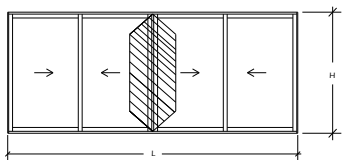

Pressão de ensaio (Pa)

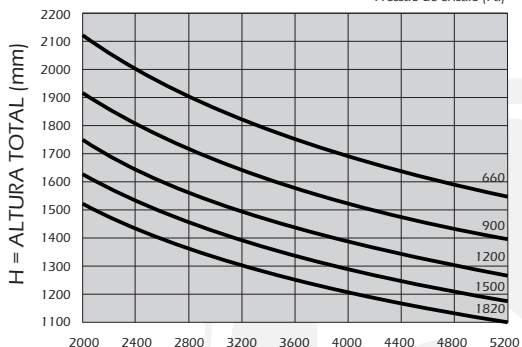

L = LARGURA TOTAL (mm)

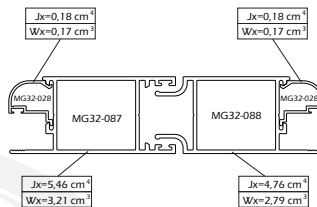

Jxt = 10,58 cm⁴

Central 4 folhas

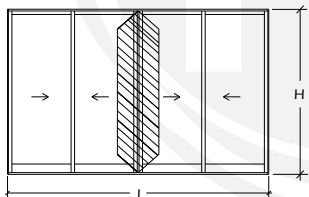

Pressão de ensaio (Pa)

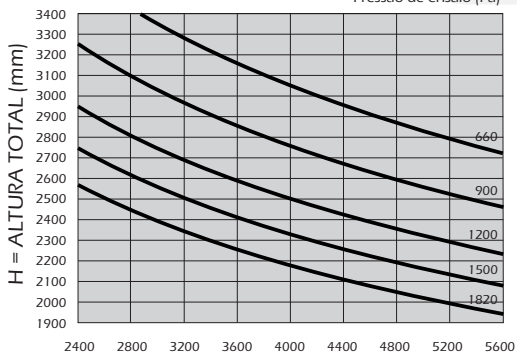

L = LARGURA TOTAL (mm)

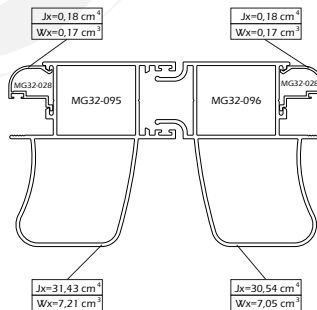

Jxt = 62,33 cm⁴

Montante Central

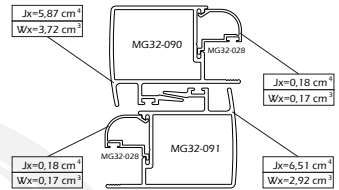
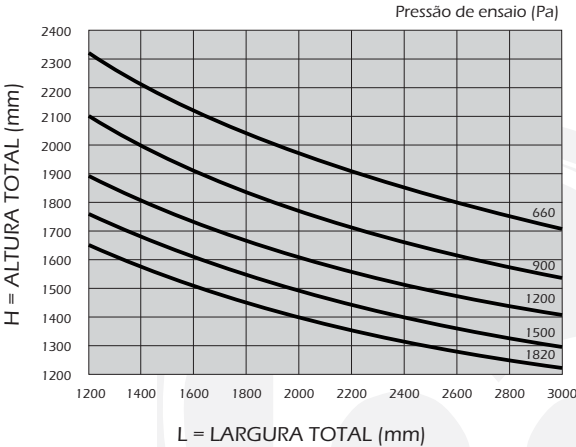
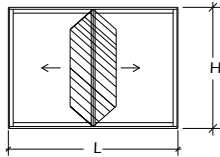

$J_{xt} = 12,74 \text{ cm}^4$

Montante Central

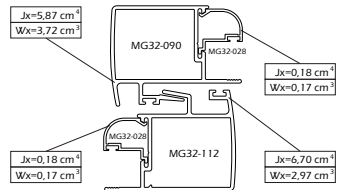
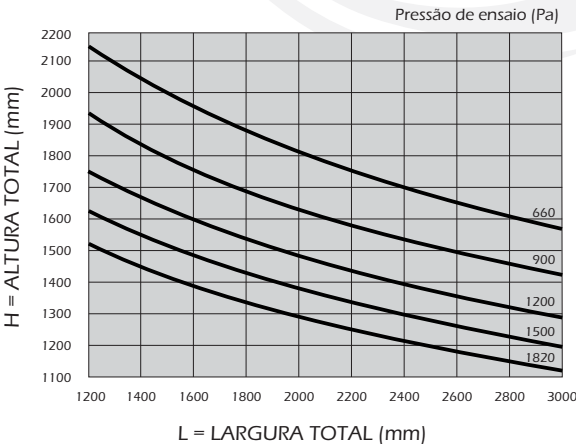
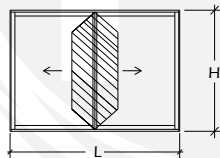

$J_{xt} = 12,93 \text{ cm}^4$

Montante central

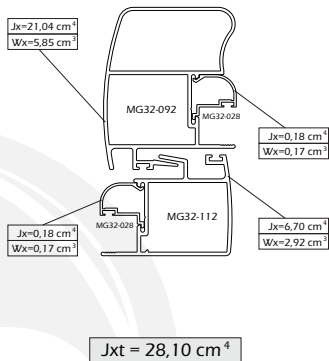
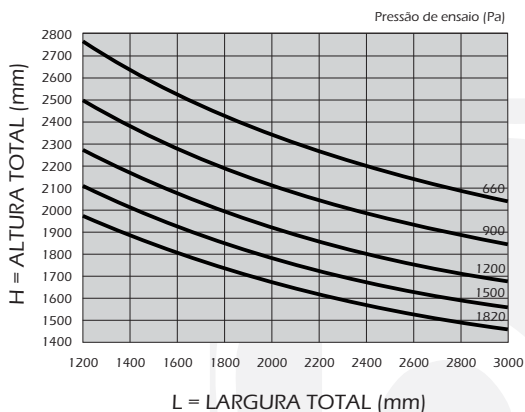
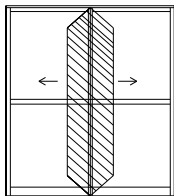

Montante Central

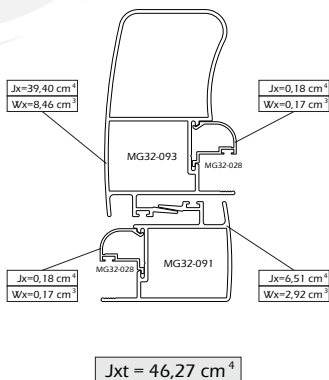
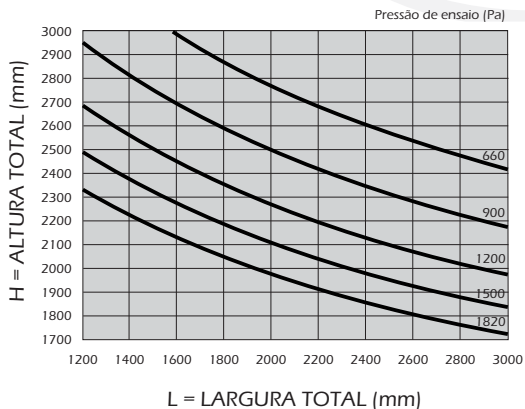
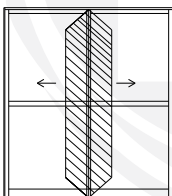

Montante Central

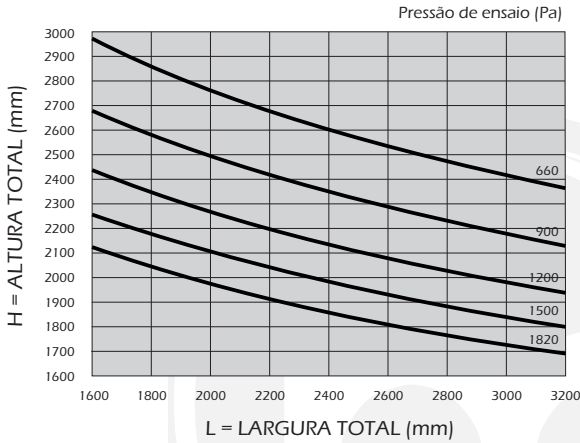
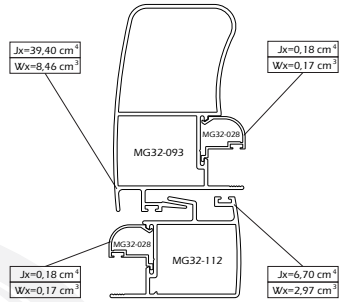
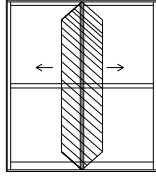

Montante Central

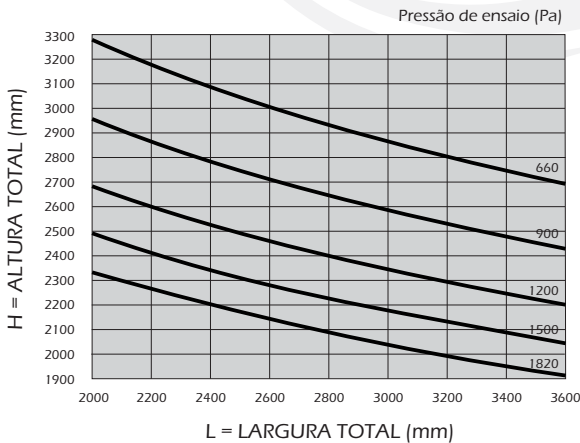
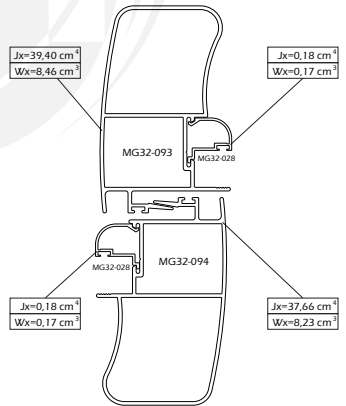
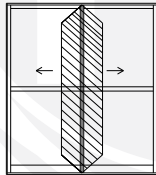

Montante central

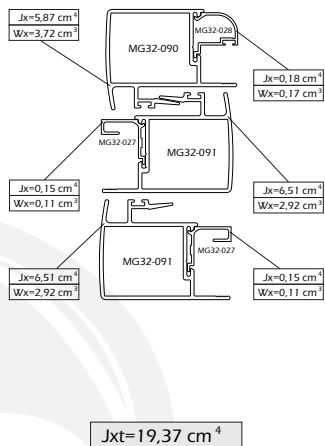
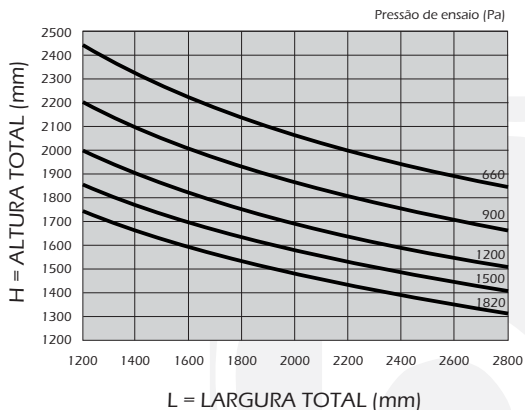
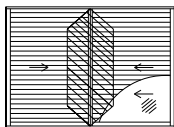

Montante Central

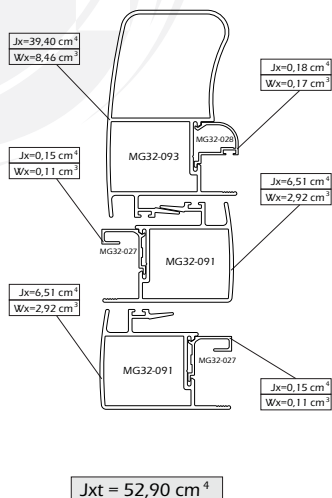
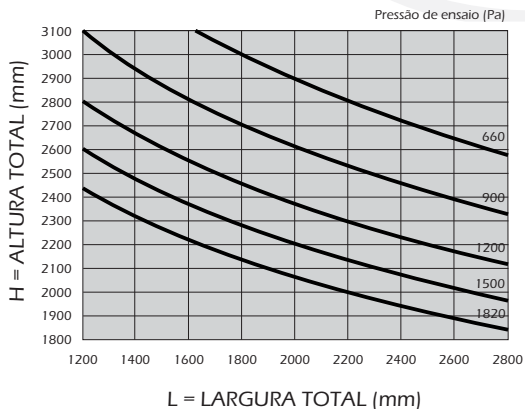
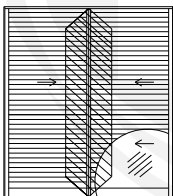

Central 4 folhas

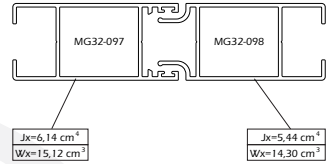
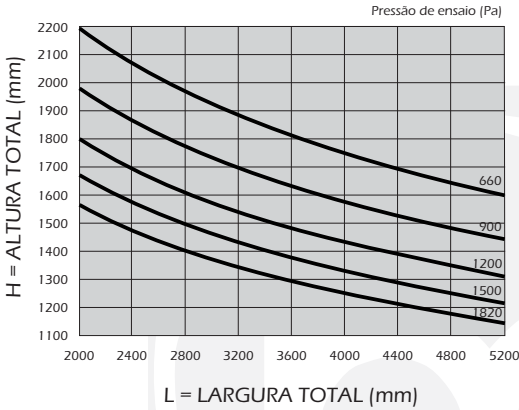
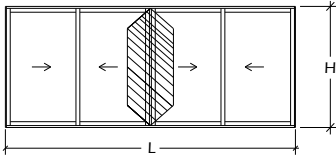

$J_{xt}=11,58 \text{ cm}^4$

Central 4 folhas

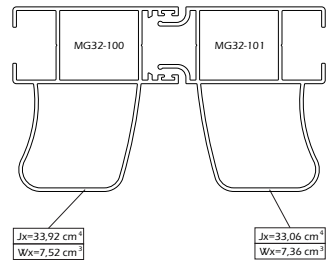
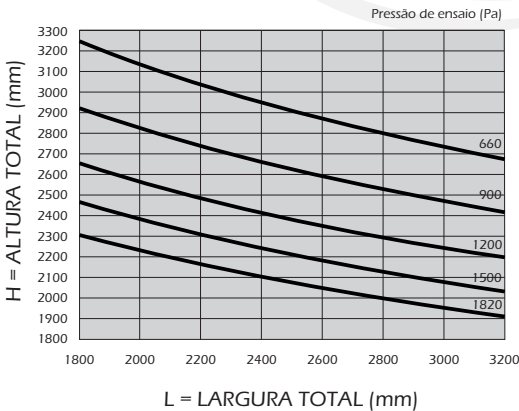
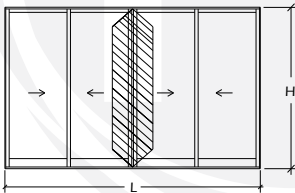

$J_{xt}=66,98 \text{ cm}^4$

Montante Central

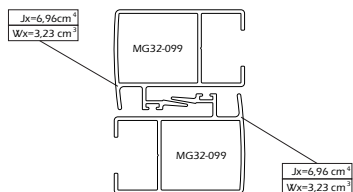
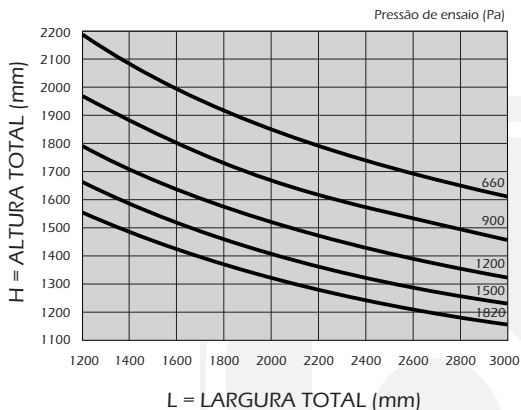
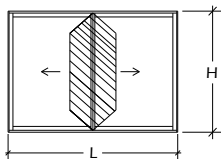

Jxt=13,92 cm⁴

Montante Central

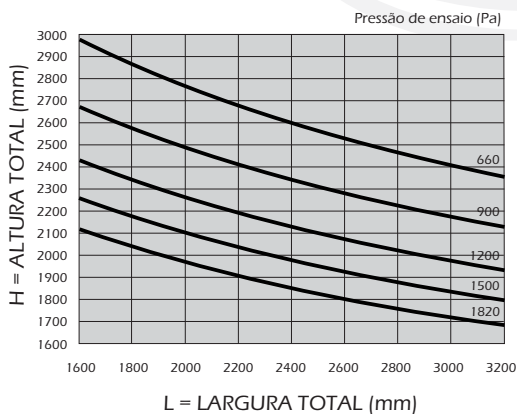
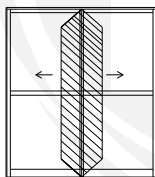

Jx=38,90 cm²
Wx=8,23 cm²

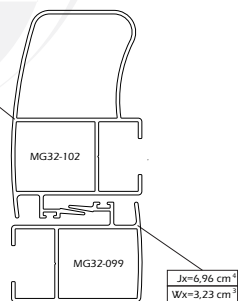

Jxt=45,86 cm⁴

Montante Central

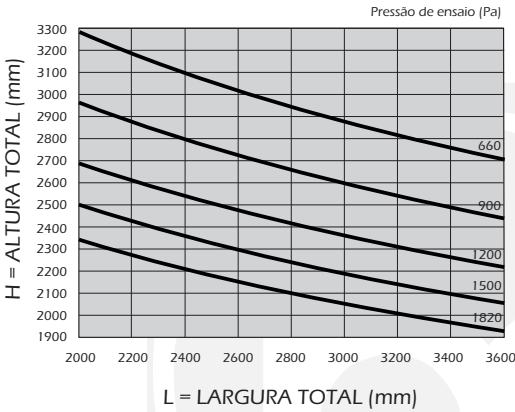
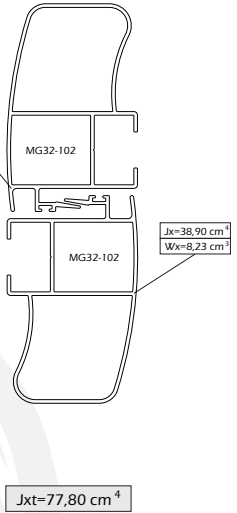
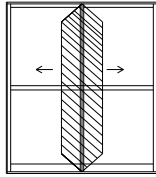

Montante Central

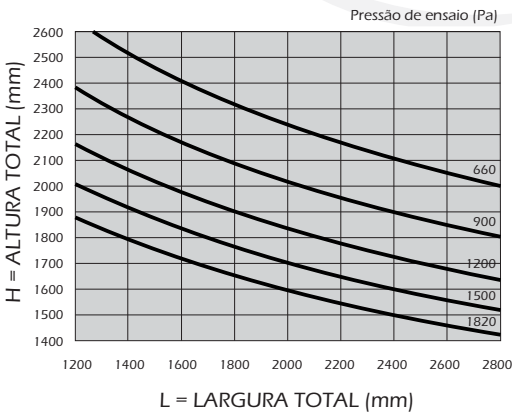
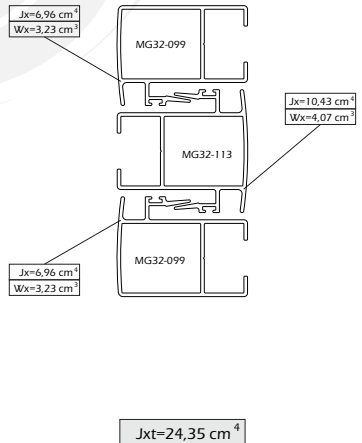
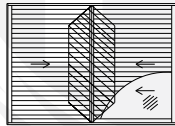

Montante central

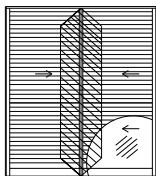

Pressão de ensaio (Pa)

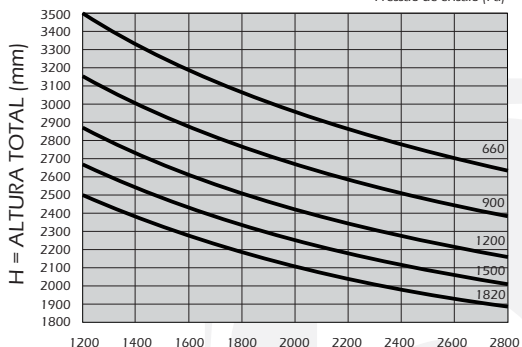

L = LARGURA TOTAL (mm)

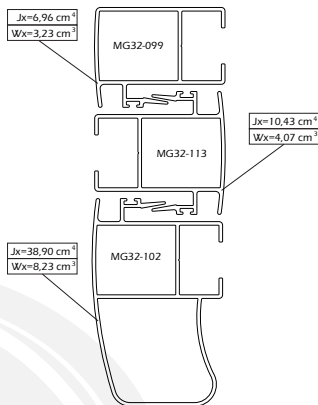

$J_{xt} = 56,29 \text{ cm}^4$

Montante Central

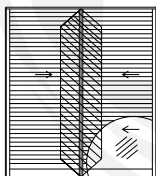

Pressão de ensaio (Pa)

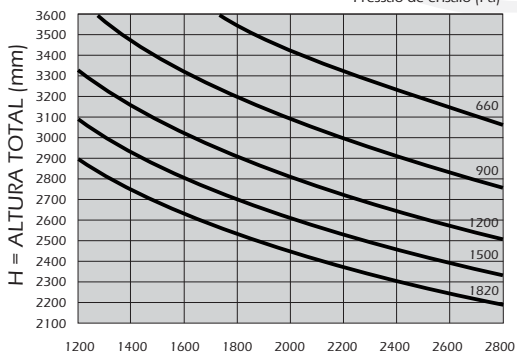

L = LARGURA TOTAL (mm)

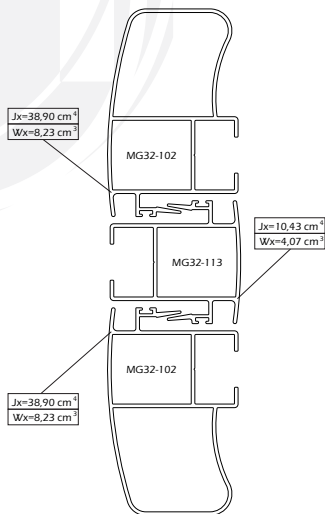

$J_{xt} = 88,23 \text{ cm}^4$



NORMAS

Isopletas dos ventos
(em metros por segundo)



Figura 1

Gráfico das isopletas da velocidade básica do vento: "V" em m/s no Brasil.

No Brasil, o comportamento estrutural de uma esquadria esta regulamentada pela NORMA NBR 10821.

Esta norma fixa as condições de desempenho de caixilhos em edificações residenciais e comerciais e visa assegurar ao consumidor, o recebimento de produtos com condições mínimas exigíveis de

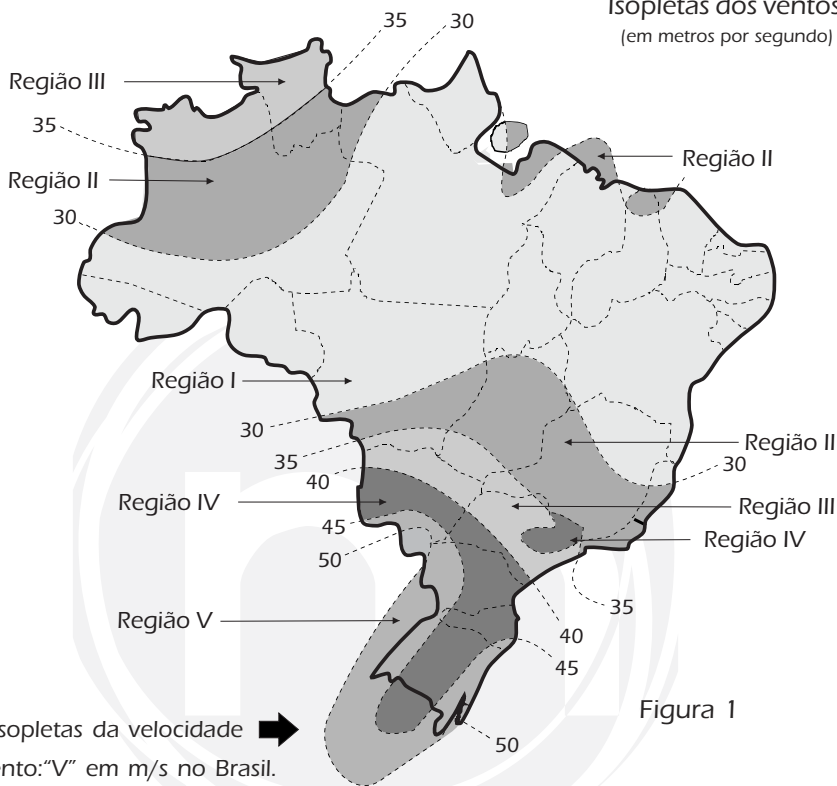
desempenho, especificamente quanto à resistência a cargas uniformemente distribuídas e que apresenta um roteiro de cálculo da pressão de ensaio (vento e vedação).

ABNT NBR 10821 - Esquadrias externas para edificações

Tabela 1

Quantidade de pavimentos	Altura máxima	Região do País	Pressão de ensaio (Pa) Positiva e negativa $P_e = P_p \times 1,2$	Pressão de segurança (Pa) Positiva e negativa $P_s = P_e \times 1,5$	Pressão de água (Pa) $P_a = P_p \times 0,20$
02	6 m	I	350	520	60
		II	470	700	80
		III	610	920	100
		IV	770	1160	130
		V	950	1430	160
05	15 m	I	420	640	70
		II	580	860	100
		III	750	1130	130
		IV	950	1430	160
		V	1180	1760	200
10	30 m	I	500	750	80
		II	680	1030	110
		III	890	1340	150
		IV	1130	1700	190
		V	1400	2090	230
20	60 m	I	600	900	100
		II	815	1220	140
		III	1060	1600	180
		IV	1350	2020	220
		V	1660	2500	280
30	90 m	I	660	980	110
		II	890	1340	150
		III	1170	1750	200
		IV	1480	2210	250
		V	1820	2730	300

